

Operating Instructions

E50 R

Fully Automatic Hand Knife Sharpening Machine



Operating Instructions

E 50 R Fully Automatic Hand Knife Sharpening Machine

Manufacturer

KNECHT Maschinenbau GmbH
Witschwender Straße 26
88368 Bergatreute
Germany

Phone +49-7527-928-0
Fax +49-7527-928-32

mail@knecht.eu
www.knecht.eu

Documents for machine operator

Operating Instructions

Date of issue of the operating instructions

March 26, 2026

Copyright

These operating instructions as well as the operating documents remain the copyright property of KNECHT Maschinenbau GmbH. They are supplied only to customers and operators of our products and belong to the machine.

Without our express permission, these documents may neither be duplicated nor made accessible to third parties, in particular competitor companies.

Table of Contents

1.	Important notes	8
1.1	Preface to the operating instructions	8
1.2	Warnings and symbols in the operating instructions	8
1.3	Warning and mandatory signs and their meaning	9
1.3.1	Warning and mandatory signs on/in the grinding machine	9
1.3.2	General mandatory signs	9
1.4	Rating plate and machine serial number	10
1.5	Figure and position numbers in the operating instructions	10
2.	Safety	11
2.1	Basic safety instructions	11
2.1.1	Observe notes in the operating instructions	11
2.1.2	Obligation on the part of the operator	11
2.1.3	Obligation on the part of the personnel	11
2.1.4	Hazards involved in handling the grinding machine	11
2.1.5	Malfunctions	12
2.2	Intended use	12
2.3	Warranty and liability	12
2.4	Safety regulations	13
2.4.1	Organizational measures	13
2.4.2	Protective equipment	13
2.4.3	Informal safety measures	13
2.4.4	Selection and qualification of personnel	13
2.4.5	Machine control system	14
2.4.6	Safety measures in normal operation	14
2.4.7	Hazards due to electrical power sources	14
2.4.8	Particular hazard areas	14
2.4.9	Servicing (maintenance, repair) and fault rectification	15
2.4.10	Structural alterations to the grinding machine	15
2.4.11	Cleaning the grinding machine	15
2.4.12	Lubricants/oils and greases	15
2.4.13	Refrigerants/Fluorinated greenhouse gases	15
2.4.14	Relocation of the grinding machine	16
3.	Description	17
3.1	Intended use	17
3.2	Technical specifications	17
3.3	Functional description	19
3.4	Description of the assemblies	20
3.4.1	Deburring and polishing units	22
3.4.2	Pneumatics	22
3.4.3	Coolant pump	22

Table of Contents

3.4.4	Flow monitor	23
3.4.5	Door sharpness testing device	23
3.4.6	Switching the grinding machine on/off	23
3.4.7	Control panel	24
3.4.8	Layout of user interface (main screen)	25

4. Transport 27

4.1	Transport aids	27
4.2	Transport damage	27
4.3	Transport to another installation site	27

5. Installation 28

5.1	Selection of qualified personnel	28
5.2	Installation site	28
5.3	Supply connections	28
5.4	Settings	28
5.5	Initial start-up of the grinding machine	29
5.5.1	Adjusting the magazine trolleys	30

6. Commissioning 31

7. Operation 35

7.1	Switch on the grinding machine	35
7.2	Grinding hand knives	35
7.2.1	Loading the knife magazines	35
7.2.2	Move the knife magazines into the grinding machine	36
7.2.3	Grinding hand knives	37
7.3	Replacing the wet-grinding belts	38
7.3.1	Adjusting the belt movement	41
7.4	Replacing the deburring rings	44
7.4.1	Adjusting the deburring rings	49
7.5	Replacing the polishing rings	50
7.5.1	Adjusting the polishing rings	55
7.6	Replacing the polishing pastes	56
7.6.1	Replacing the polishing paste of the deburring unit	56
7.6.2	Replacing the polishing paste of the polishing unit	57
7.7	Replacing the test medium of the sharpness testing device	59
7.7.1	Calibrating the sharpness testing device	60

Table of Contents

8.	Control	63
8.1	Main screen	63
8.2	Settings	65
8.3	Product data	67
8.3.1	Loading the product data	67
8.3.2	Changing the product data	68
8.4	Manual functions	69
8.4.1	General	69
8.4.2	Grinding belt	70
8.4.3	Deburring unit	70
8.4.4	Polishing unit	71
8.4.5	General	71
8.5	Message texts	72
8.6	Options	72
8.7	Changing the language	73
8.8	Setting up an internet connection	75
9.	Care and maintenance	76
9.1	Replacing the coolant water	76
9.2	Cleaning	76
9.2.1	Cleaning agent and lubricant table	77
9.2.2	Checking and cleaning the suction unit	77
9.2.3	Cleaning the flow monitor	79
9.2.4	Cleaning the knife magazines	80
9.3	Lubrication points	81
9.3.1	Lubricating the motors for the grinding belt drive	81
9.3.2	Lubricating the gripper	82
9.3.3	Lubricating the sliding door	84
9.4	Maintenance plan (one-shift operation)	85
10.	Disassembly and disposal	86
10.1	Disassembly	86
10.2	Disposal	86
11.	Service, spare parts and accessories	87
11.1	Postal address	87
11.2	Service	87
11.3	Wear and spare parts	87
11.4	Accessories	88
11.4.1	Abrasives used and others	88

Table of Contents

12.	Appendix	89
12.1	EU Declaration of Conformity	89

1. Important notes

1.1 Preface to the operating instructions

These operating instructions are intended to make it easy to learn how to use the fully automatic grinding machine for hand knives, hereafter referred to as the grinding machine, and to properly utilize its features.

These operating instructions contain important notes on how to operate the grinding machine safely, properly and efficiently. Observing these instructions helps to avoid hazards, reduce repair costs and downtimes, and to increase the reliability and service life of the grinding machine.

The operating instructions must be permanently available at the place of use of the grinding machine.

The operating instructions must be read and applied by every person tasked with working with the grinding machine, e.g.:

- transport, installation, commissioning
- operation, including error rectification during operation, as well as
- servicing (maintenance, repair).

Recognized technical standards for safe and professional work must be observed in addition to these operating instructions and the binding accident prevention regulations applicable in the country of use and at the place of use.

1.2 Warnings and symbols in the operating instructions

The operating instructions use the following symbols/designations that must be followed:



The hazard triangle with the signal word "CAUTION" serves as a work safety notice for all work for which there is a risk of personal injury or death.

In these cases, work should be done with special attention and care.



"ATTENTION" is written in places where special attention must be paid to prevent damage or destruction of the grinding machine or its surroundings.



"NOTICE" refers to user tips and especially useful informations.

1. Important notes

1.3 Warning and mandatory signs and their meaning

1.3.1 Warning and mandatory signs on/in the grinding machine

The following warnings and mandatory signs have been affixed on/in the grinding machine:

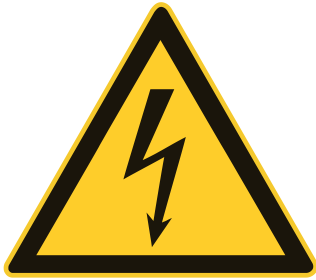

CAUTION! CAUTION! DANGEROUS ELECTRICAL VOLTAGE! (warning sign on the control cabinet)

The grinding machine carries life-threatening voltage when it is connected to the power supply.

Voltage-carrying device parts may only be opened by authorized personnel.

The grinding machine must be separated from the mains supply before carrying out servicing, maintenance and repair work on it.

1.3.2 General mandatory signs

The following general mandatory signs must be observed:



CAUTION! RISK OF INJURY FROM ABRASIVE PARTICLES!

Wearing eye protection is mandatory when carrying out general maintenance and cleaning work.



CAUTION! RISK OF INJURY FROM KNIFE!

Working with the grinding machine involves grinding knives that could cause serious cut injuries due to their sharpness.

Cut-resistant gloves must be worn when inserting and removing knives.

Caution when transporting knives. Use the protective equipment provided by the knife manufacturer. Cut-resistant gloves and safety shoes must be worn.

1. Important notes

1.4 Rating plate and machine serial number



Figure 1-1 Rating plate

The rating plate (1-1) is located on the right side of the machine behind the control cabinet.

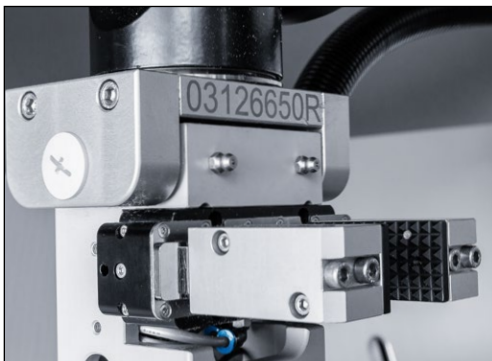

Figure 1-2 Machine number

The machine serial number (1-2) is located on the rating plate (1-1) and on the knife gripper.

1.5 Figure and position numbers in the operating instructions

If the text makes a reference to a machine component depicted in a figure, the figure and position number will be given in brackets.

Example: (7-22/1) means figure number 7-22, item 1.



Figure 7-22 Removing the protection hood

Remove the protection hood (7-22/1) and clean it under running water.

2. Safety

2.1 Basic safety instructions

2.1.1 Observe notes in the operating instructions

The basic prerequisite for the safe handling and uninterrupted operation of this grinding machine is knowledge of the basic safety instructions and regulations.

- These operating instructions contain important notes on how to operate the grinding machine safely.
- All persons carrying out work on the grinding machine must follow these operating instructions, in particular the safety notices.
- In addition, the rules and regulations regarding accident prevention at the place of use are to be observed.

2.1.2 Obligation on the part of the operator

The operator is obliged to allow only those persons to work on the grinding machine, who

- are familiar with the occupational safety and accident prevention regulations and have received instruction in handling the grinding machine,
- have read and understood the operating instructions, in particular the section entitled "Safety" and the warning notes, and have provided signed confirmation of this.

The safety-awareness of the personnel at work will be monitored at regular intervals.

2.1.3 Obligation on the part of the personnel

All personnel working on the grinding machine shall be obliged, before starting work, to

- observe basic occupational safety and accident prevention regulations,
- read the operating instructions, particularly the section entitled "Safety" and the warning notes, and provide signed confirmation that they have understood them.

2.1.4 Hazards involved in handling the grinding machine

The grinding machine has been built to the latest technological standards and the recognized rules of technical safety. Nevertheless, its use may result in danger to life and limb of the user or third parties, or damage to the grinding machine or other property.

The grinding machine may be used only:

- for its intended purpose
- in a safe and secure condition.

Malfunctions that may impair safety are to be eliminated immediately.

2. Safety

2.1.5 Malfunctions

If safety-relevant malfunctions occur with the grinding machine, or if the processing behavior indicates that such malfunctions may have occurred, the grinding machine must be stopped immediately and until such time as the malfunction has been found and eliminated.

Allow only authorized trained personnel to eliminate the malfunctions.

2.2 Intended use

The grinding machine is only suitable for grinding, deburring and polishing hand knives (70–270 mm in length). All knives must be inserted into the provided knife magazines.

Any other use or use beyond this is not considered as intended. KNECHT Maschinenbau GmbH is not liable for any damage resulting from this. The risk is borne solely by the user.

Intended use also includes observing all instructions in the operating manual.

ATTENTION

Improper use of the grinding machine exists, for example, if:

- **workpieces other than hand knives are ground.**

2.3 Warranty and liability

Warranty and liability claims in case of personal injury or property damage are excluded if such damage is attributable to one or more of the following causes:

- improper use of the grinding machine,
- improper transport, commissioning, operation, and maintenance of the grinding machine,
- operating the grinding machine with defective safety devices, or using improperly attached or malfunctioning safety and protective equipment,
- failure to observe the instructions with regard to transportation, commissioning, operation, maintenance and repair of the grinding machine,
- unauthorized structural alterations to the grinding machine,
- unauthorized modification, e.g. of the drive conditions (output and speed),
- failure to monitor machine parts that are subject to wear, and
- use of unapproved replacement and wear parts.

2. Safety

Use only original replacement and wear parts. If externally purchased parts are used, it is not guaranteed that they have been designed and manufactured to meet the requirements in terms of stress and safety.

2.4 Safety regulations

2.4.1 Organizational measures

Inspect all available safety devices regularly.

Observe prescribed intervals for recurring maintenance work or as specified in the operating instructions!

2.4.2 Protective equipment

Before every commissioning of the grinding machine, ensure that all protective equipment is properly mounted and in functional condition.

Protective equipment may only be removed after the grinding machine has come to a complete stop and has been secured against restarting.

When attaching spare parts, the protective equipment must be attached by the operator as stipulated.

2.4.3 Informal safety measures

The operating instructions must be permanently available at the place of use of the grinding machine. In addition to the operating instructions, the generally applicable as well as locally relevant accident prevention regulations must also be made available and observed.

All safety alert symbols and hazard warnings on the grinding machine must be complete and clearly legible.

2.4.4 Selection and qualification of personnel

Only trained and instructed personnel may work on the grinding machine. Observe the legally permitted minimum age!

The responsibilities of personnel with respect to commissioning, operation, maintenance, and repair must be clearly specified.

Personnel still undergoing training or instruction may only work on the grinding machine under the permanent supervision of an experienced person!

2. Safety

2.4.5 Machine control system

Under no circumstances make program changes to the software. Parameters that the operator can set himself are excluded from this (e.g. setting the number of cycles).

Only trained and instructed personnel are permitted to switch on and operate the machine.

2.4.6 Safety measures in normal operation

Do not operate the machine in any unsafe manner. Only operate the grinding machine if all the safety devices are installed and fully functional.

At least once per shift (or per day), check the grinding machine for externally visible damage and proper functioning of the safety devices.

Immediately report any changes present (including those of the operating behavior) to the responsible office or person. If necessary, immediately shut down the grinding machine and secure it against restart.

Before you switch on the grinding machine, ensure that no one can be injured by the start-up of the machine.

In the event of a malfunction, immediately stop the grinding machine and secure it against restart. Rectify malfunctions immediately.

2.4.7 Hazards due to electrical power sources

The control cabinet must always be kept closed. Only authorized personnel must be allowed to access it.

Work on electrical systems or operating materials may only be performed by a qualified electrician, in accordance with electrical regulations.

Defects, such as damaged cables, cable connections, etc. must be immediately rectified by an authorized specialist.



The yellow power supply cable is electrically live even when the main switch is turned off.

2.4.8 Particular hazard areas

If the knife gripper is being used manually, there is a pinching hazard from the gripper.

2. Safety

2.4.9 Servicing (maintenance, repair) and fault rectification

Maintenance work is to be carried out on schedule by trained personnel. Inform operating personnel before beginning repair work. Designate a supervisor responsible for this.

For all service work, the grinding machine is to be disconnected from the current supply and secured against accidental restart. Remove power plug. Secure repair area as necessary.

After completing maintenance work and rectifying any faults, install all safety devices and verify that they are fully functional.

2.4.10 Structural alterations to the grinding machine

Do not make any changes, additions or conversions to the grinding machine without the approval of the manufacturer. This also applies to the installation and setup of safety devices.

Any conversion work requires the written permission from KNECHT Maschinenbau GmbH.

Immediately replace machine parts that are not in perfect condition.

Use only original replacement and wear parts. If externally purchased parts are used, it is not guaranteed that they have been designed and manufactured to meet the requirements in terms of stress and safety.

2.4.11 Cleaning the grinding machine

Properly handle any cleaning agents and materials used and dispose of them in an environmentally-friendly manner.

Dispose of the wear parts and replacement parts in a safe and environmentally-friendly manner.

2.4.12 Lubricants / oils and greases

When using oils and greases, follow the safety regulations applicable to the product. Comply with the special regulations for the food areas.

2.4.13 Refrigerants / Fluorinated greenhouse gases

The control unit's cooling device contains fluorinated greenhouse gases (F-gases) in accordance with EU Regulation 2024/573.

The refrigerant R 513A is used with a filling quantity of 0.17 kg, which corresponds to a CO₂ equivalent of 0.11 t and a global warming potential (GWP) of 631.

The applicable regulations for F-gases must be observed during maintenance, repair, or disposal. Work on the refrigerant may only be carried out by qualified personnel.

2. Safety

2.4.14 Relocation of the grinding machine

Disconnect the grinding machine from any external power supply, even in the event of a minor change of location. Before restarting the grinding machine, connect it properly to the power supply.

For loading work, use only lifting equipment and load-bearing devices with sufficient lifting capacity. Appoint a qualified instructor for the lifting operation.

No persons other than those designated for this work may be present in the loading and installation area.

Only lift the grinding machine correctly with a suspension device in accordance with the operating instructions (attachment points for load suspension devices, etc.). Only use a suitable transport vehicle with sufficient load-bearing capacity. Secure the load reliably. Use suitable attachment points.

When restarting the machine, proceed only in accordance with the operating instructions.

3. Description

3.1 Intended use

The E50 R Hand Knife Sharpening Machine sharpens, deburrs and polishes hand knives with a length of 70–270 mm fully automatically. A six-axis robot removes the knife from the magazine, measures the knife shape optically, processes the knife and then returns it to the magazine. Optionally, the sharpness of the knife can be checked.

3.2 Technical specifications

Height (max. with the sliding door open)	_____	approx. 2900 mm
Width	_____	approx. 2585 mm
Depth (incl. magazine trolley)	_____	approx. 2710 mm
Space requirement (WxDxH)	_____	approx. 4000 x 3500 x 3000 mm
Permitted room temperature	_____	+10–+35 °C
Permitted air humidity	_____	20–80%
Weight (incl. knife magazines)	_____	approx. 1600 kg
Weight magazine trolley	_____	approx. 48 kg
Power supply*	_____	3x 400 V
Mains frequency*	_____	50/60 Hz
Output*	_____	8 kW
Current consumption*	_____	11 A
Back-up fuse	_____	25 A
Control voltage	_____	24 V DC
Operating noise level (measured A-weighted emission sound pressure level at the workplace LpA)**	_____	approx 72 dB(A)
Compressed air supply according ISO 8573-1:2010 [1:4:2]	_____	6–6.5 bar
Air consumption	_____	max. 50 l/min
Diameter polishing rings	_____	180 mm
Speed polishing rings	_____	2200 rpm
Diameter deburring rings	_____	180 mm
Speed deburring rings	_____	2200 rpm

3. Description

Speed of wet-grinding belt _____ 1500 rpm

Maximum knife length _____ 270 mm

Suction capacity _____ max. 300 m³/h

Particle diameter cartridge filter _____ 3.2 µm

Control unit cooling device***

Refrigerant type _____ R-513A

Filling quantity _____ 0.17 kg

CO₂ equivalent _____ 0,11 t

GWP (Global Warming Potential) _____ 631

*) This information may change depending on the electrical power supply.

**) Two-digit noise emission value indication according to EN ISO 4871. Noise emission value indication according to EN ISO 11201, measurement uncertainty KpA: 3 dB(A). A hand knife from Giesser was sharpened.

***) The cooling device contains fluorinated greenhouse gases in accordance with EU Regulation 2024/573.

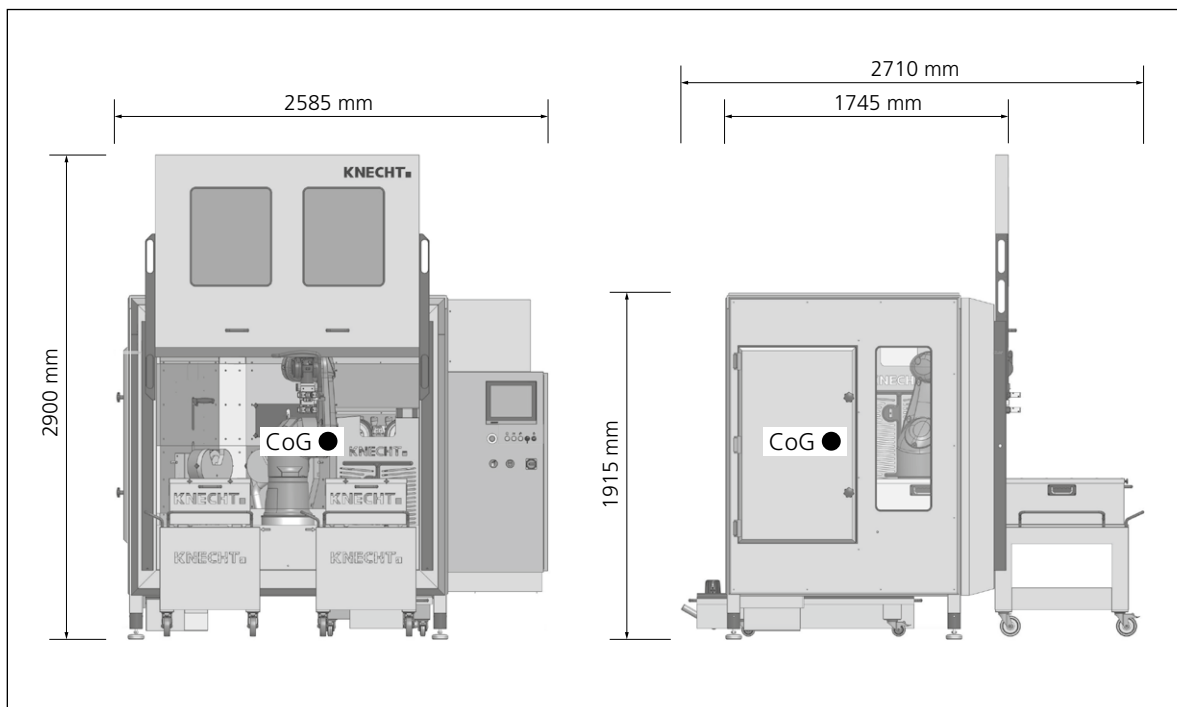

Figure 3-1 Dimensions in mm and center of gravity (CoG) of the machine

3. Description

3.3 Functional description

The E50 R Hand Knife Sharpening Machine can be used to grind, deburr and polish hand knives fully automatically.

The operator inserts the hand knives into the knife magazine. After the start, the knife gripper of the six-axis robot removes the first knife, measures it and feeds it to the grinding, deburring and polishing stations. After the grinding process is complete, the tool is returned to the magazine before the next knife is processed. Optionally, the sharpness of the knives can be checked.

In the event of an emergency, the hand knife sharpening machine can immediately be stopped by pressing the "Emergency Stop" button.

3. Description

3.4 Description of the assemblies



Figure 3-2 General view of grinding machine

- 1 Sliding door
- 2 Knife magazine
- 3 Magazine trolley
- 4 Control and control cabinet
- 5 Water tray
- 6 Adjustable machine feet

3. Description

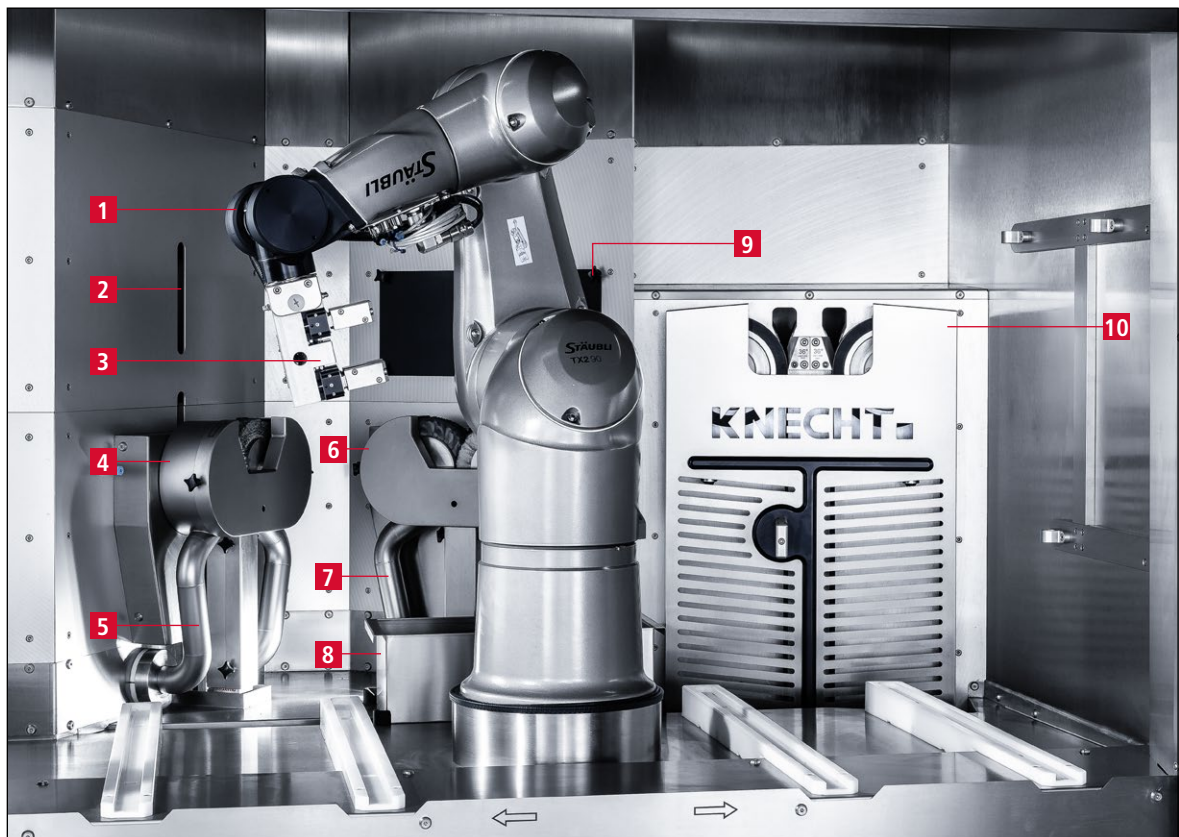

Figure 3-3 Interior

- 1 Robot
- 2 Sharpness testing device (optional)
- 3 Knife gripper
- 4 Deburring unit
- 5 Suction unit (deburring unit)
- 6 Polishing unit
- 7 Suction unit (polishing unit)
- 8 Collection container
- 9 Measuring device
- 10 Grinding unit

3. Description

3.4.1 Deburring and polishing units



Figure 3-4 Deburring and polishing units

- 1 Deburring unit
- 2 Polishing unit

3.4.2 Pneumatics

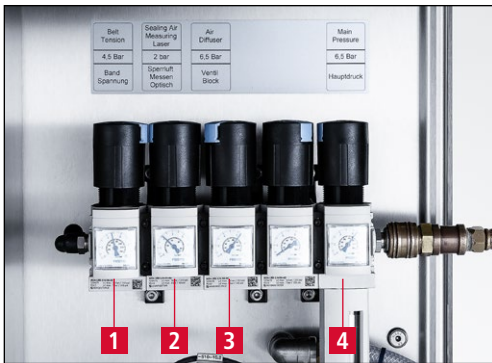

Figure 3-5 Pneumatics

- 1 Belt tension 4.5 bar
- 2 Sealing air „Measuring device“ 2 bar
- 3 Valve block 6.5 bar
- 4 Main pressure 6.5 bar

3.4.3 Coolant pump

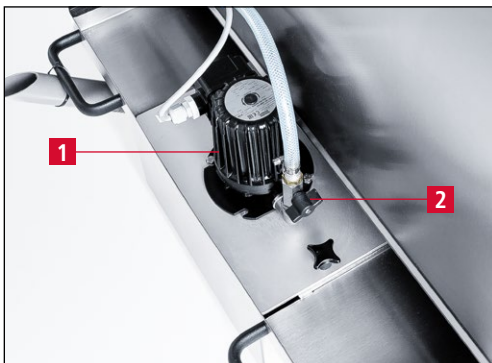

Figure 3-6 Coolant pump

- 1 Coolant pump

The coolant flow is regulated using the ball tap (3-6/2).

3. Description

3.4.4 Flow monitor



Figure 3-7 Flow monitor

The flow monitor (3-7/1) controls the coolant flow. If there is insufficient coolant, it sends a signal to shut down the automatic process.

3.4.5 Door sharpness testing device



Figure 3-8 Door sharpness testing device

1 Door sharpness testing device

3.4.6 Switching the grinding machine on/off

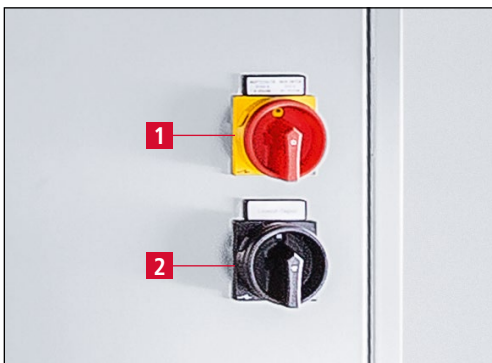

Figure 3-9 Main switch

The main switch (3-9/1) is located on the control panel.

Turning the main switch to position "1 ON" activates the grinding machine ready for operation.

Turning the main switch to position "0 OFF" disconnects the grinding machine from the power supply.

Lockout-Tagout switch (3-9/2): (only present on machines for the USA)

3. Description

3.4.7 Control panel



Figure 3-10 Control panel

- 1 Touch panel
- 2 "Emergency stop" button
- 3 "Control ON" button: activate control (when button flashes)
- 4 "Start/Stop" button: start/stop grinding program
- 5 "Coolant pump on/off" button: switch coolant pump on/off (for cleaning)
- 6 USB port
- 7 "Service on/off" key switch: position "1" for setup mode, position "0" for automatic mode.

3. Description

3.4.8 Layout of user interface (main screen)

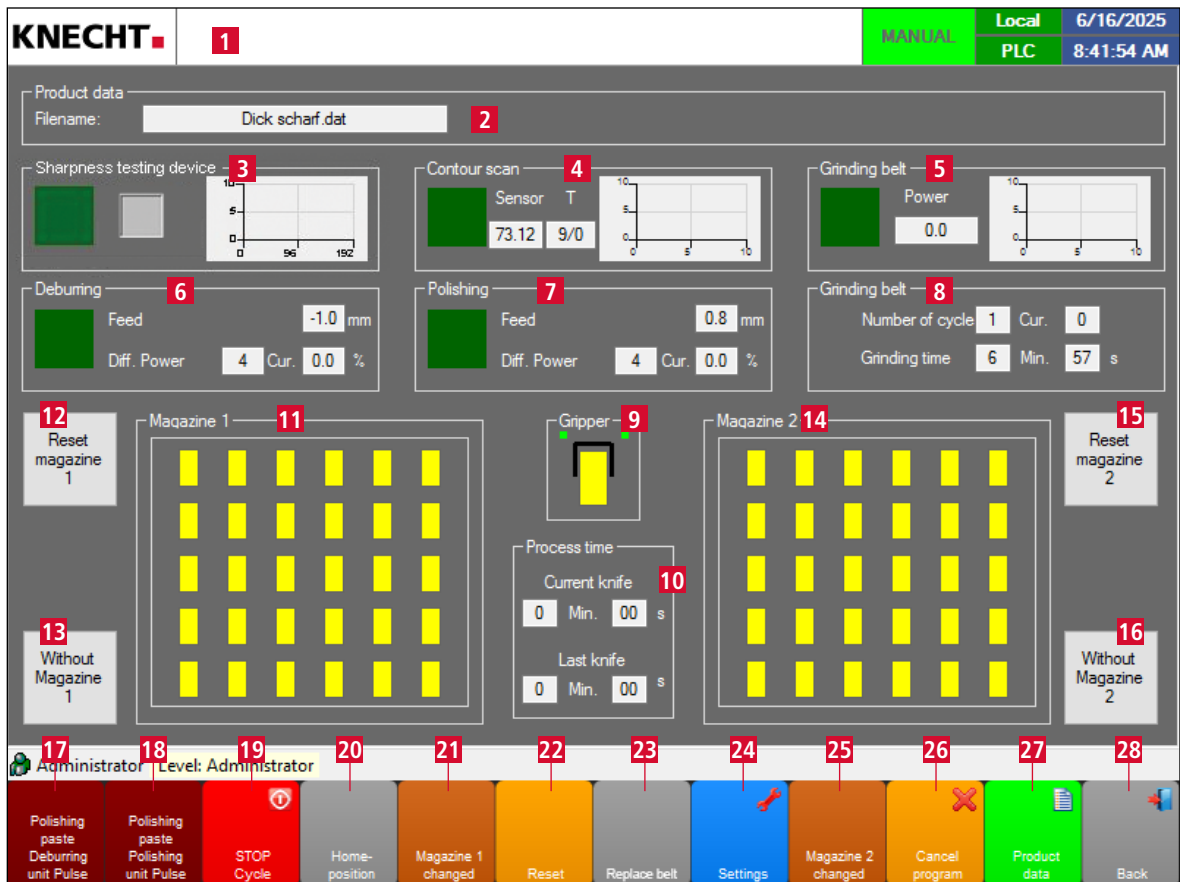

Figure 3-11 Main screen

- 1 Errors and general messages (double-tap to open message texts)
- 2 Product data (loaded product data)
- 3 Sharpness testing device (optional) (activate/deactivate using the green button; tap the diagram to open it)
- 4 Contour capture (tap the diagram to open it)
- 5 Grinding belt (activate the wet-grinding belts using the green button; tap the diagram to open it; performance)
- 6 Deburring (feed and diff. power, activate/deactivate the deburring unit using the green button)
- 7 Polishing (feed and diff. power, activate/deactivate the polishing unit using the green button)
- 8 Grinding belt (number of cycles and grinding time, wet-grinding belt rotated)
- 9 **"Gripper"**: Tapping the gripper symbol opens/closes knife gripper
- 10 Processing duration (current and last knife)
- 11 Magazine 1
- 12 **"Reset magazine 1"**: empty knife magazine 1
- 13 **"Without Magazine 1"**: do not process magazine 1 (activate/deactivate)
- 14 Magazine 2

3. Description

- 15 **“Reset Magazine 2”**: empty knife magazine 2
- 16 **“Without Magazine 2”**: do not process magazine 2 (activate/deactivate)
- 17 **“Polishing paste Deburring unit Pulse”**: feed polishing paste Deburring unit one time
- 18 **“Polishing paste Polishing unit Pulse”**: feed polishing paste Polishing unit one time
- 19 **“STOP cycle”**: stop processing after the currently active knife
- 20 **“Homeposition”**: run machine to initial position
- 21 **„Magazine 1 changed”**: tap once to add one knife to the magazine; press and hold for 2 sec to refill the magazine
- 22 **„Reset”**: reset control
- 23 **„Belt change”**: clears the “Replace grinding belt” message (press for 5 sec)
- 24 **„Settings”**: switches to the “Settings” display
- 25 **„Magazine 2 changed”**: tap once to add one knife to the magazine; press and hold for 2 sec to refill the magazine
- 26 **„Cancel program”**: cancel current knife program and begin grinding process from beginning
- 27 **„Product data”**: load different grinding programs (for product file loaded, see (3-11/2))
- 28 **“Back”**: switch to the previous display or close user interface

NOTE

When the key-operated switch (3-10/7) is on position “1”, the knife gripper (3-3/3) can be activated even when the door is open.

Touch panel fields “Polishing paste Deburring unit Pulse” (3-11/17) and “Polishing paste Polishing unit Pulse” (3-11/18) only work in automatic mode while the deburring and polishing units are active.

Removing the knife magazine resets the machine.



CAUTION

The key-operated switch may only be operated by specialized trained personnel.

If the key-operated switch (3-10/7) is on position “1”, there is a pinching hazard from the knife gripper.

4. Transport



When transporting, observe the local applicable safety and accident prevention regulations.

Only transport the grinding machine with the machine feet facing downwards.

4.1 Transport aids

For transporting and for setting up of the grinding machine, only use adequately dimensioned transport aids. Remove the water tray before transporting.

When using a forklift or a lifting truck, move the fork under the grinding machine.

Note the machine's center of gravity when transporting. The center of gravity (CoG) is shown in Figure 3-1.

4.2 Transport damage

If damage is detected during acceptance of the delivery, immediately inform KNECHT Maschinenbau GmbH and the forwarding agent. If necessary, an independent expert must be called in immediately.

Remove packaging and fastening straps. Remove the shipping straps on the grinding machine. Dispose of packaging in an environment-friendly manner.

4.3 Transport to another installation site

For transport to another installation site, ensure that the space requirements are fulfilled (see Chapter 3.2).

A permitted electrical connection, pneumatic connection and network connection must be available at the new installation site. The grinding machine must stand firmly and securely.



Work on the electrical and pneumatic unit is only to be carried out by an authorized specialist.

Observe the locally applicable safety and accident prevention regulations.

5. Installation

5.1 Selection of qualified personnel



We recommend having the installation work on the grinding machine carried out by the trained KNECHT personnel.

We are not liable for any damage resulting from improper installation.

5.2 Installation site

When determining the installation site, bear in mind the space required for installation as well as maintenance and repair work on the grinding machine (see Chapter 3.2).

The machine may only be stored and operated in dry rooms. The temperature must be between +10°C and +35°C.

5.3 Supply connections

The grinding machine is provided ready to connect with the corresponding plug (32 A) for the power supply and a compressed air hose (5 m).

Have the power supply installed on site by a qualified electrician.

The compressed air supply and the network connection must be installed on site by a qualified technician.



Ensure that the power supply is connected correctly.

If the connection to the voltage supply is incorrect, the deburring / polishing rings can rotate in reverse of the prescribed direction. An incorrect direction of rotation can result in serious injuries and damage to the grinding machine.

Observe the prescribed rotating direction, see Chapter 6.

5.4 Settings

KNECHT Maschinenbau GmbH will configure the various components as well as the electrical system before delivery.

ATTENTION

Unauthorized alterations to the preset values are not permitted and can damage the grinding machine.

5. Installation

5.5 Initial start-up of the grinding machine

Place the grinding machine at the installation site on a level base.

Compensate uneven floors by turning the machine feet (3-2/6) with an AF24 mm open-end wrench. Align the machine using a spirit level. To do this, place the spirit level on the frame of the grinding machine.

Adjust the height of the magazine trolleys (see Chapter 5.5.1).

Have the power supply installed on site by a qualified electrician.

The compressed air supply and the network connection must be installed on site by a qualified technician.

Completely install and inspect the protective equipment before commissioning.



Have all protective equipment checked for proper functioning by authorized trained personnel before commissioning the machine.

All work may only be carried out by authorized specialist personnel.

Observe the locally applicable safety and accident prevention regulations.

Have all protective equipment (in particular the electrical safety circuits) checked for proper functioning by authorized trained personnel before commissioning the machine.

Ensure that the compressed air supply is connected correctly.

If connected incorrectly, escaping compressed air and flying parts can cause injuries.

The local safety and accident prevention regulations for compressed air must be observed.

5. Installation

5.5.1 Adjusting the magazine trolleys



Figure 5-1 Adjusting the height of the magazine trolleys

The height of the two magazine trolleys must be adjusted so that the white rails of the trolley (5-1/1) and the machine (5-1/2) are at the same height.



Figure 5-2 Adjusting the steering rollers

To do this, loosen the two hexagon screws (5-2/1) on the steering rollers using an AF 17 mm ring spanner and adjust the height accordingly.

Repeat this procedure for all steering rollers until the height of the magazine trolleys matches that of the machine.

NOTE

Since the height of the two magazine trolleys can vary on uneven ground, always pay attention to the markings for “right” and “left” (5-3/1) when moving them to the machine.



Figure 5-3 Markings on magazine trolleys

Observe the markings (5-3/1) for right/left on the magazine trolleys.

6. Commissioning



All work may only be carried out by authorized specialist personnel.

Observe the locally applicable safety and accident prevention regulations.



Figure 6-1 Water tray

Move the water tray (6-1/1) under the machine and fill it with approx. 60 liters of water to 3 cm below the rim.

ATTENTION

Only fill with cold water! Hot water will cause the flow monitor to malfunction.

NOTE

The use of a coolant additive is not intended.

Connect the power plug to the socket provided on site (3x 400 V, 32 A).

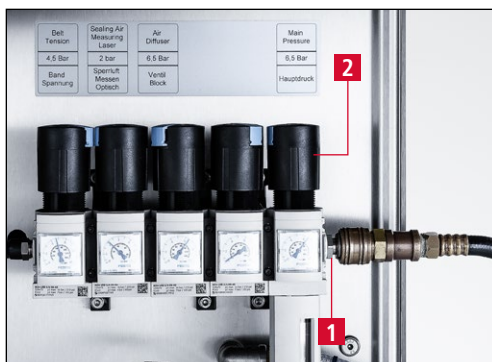

Figure 6-2 Compressed air connection

Plug in the compressed air hose at the compressed air connection (6-2/1).

Use the control knob (6-2/2) to set the pressure to 6.5 bar.

6. Commissioning

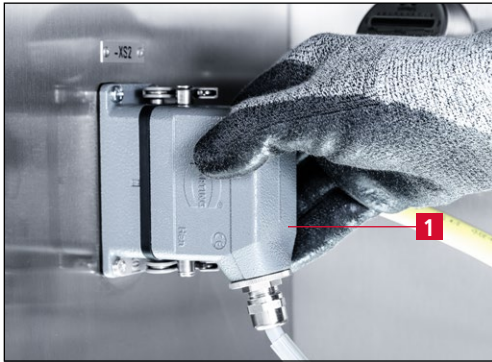

Figure 6-3 Connecting the coolant pump

Place the coolant pump in the water tray and connect the plug (6-3/1) to the control cabinet.

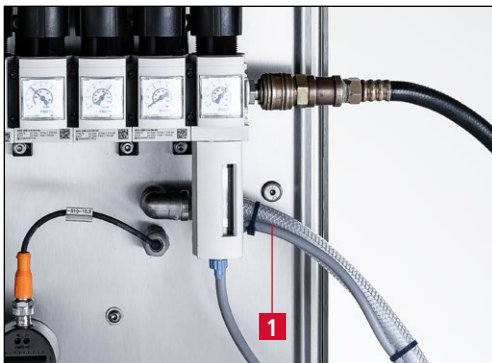

Figure 6-4 Connecting the water hose

Connect the water hose (6-4/1) from the coolant pump to the nipple under the compressed air unit and secure it with the hose clamp.

Close the sliding door.



Figure 6-5 Control panel

Set the main switch (3-9/1) to the "1 ON" position and wait for the controls to initialize.

When the "Control on" button (6-5/1) flashes, switch on the control system by pressing the button.

6. Commissioning

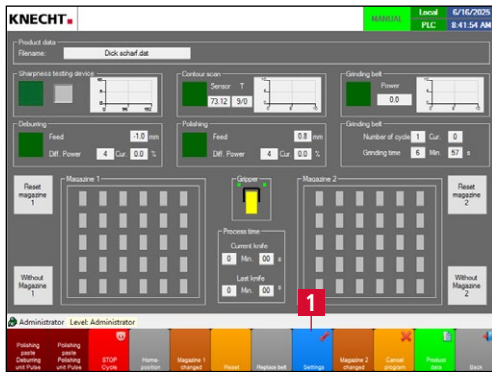

Figure 6-6 Main screen

To switch on the deburring unit, select touch panel field **“Settings”** (6-6/1) on the main screen to access the settings (6-7).



Figure 6-7 Settings

Within the settings, use the touch panel field **“Manual functions”** (6-7/1) to switch to the general manual functions (6-8).

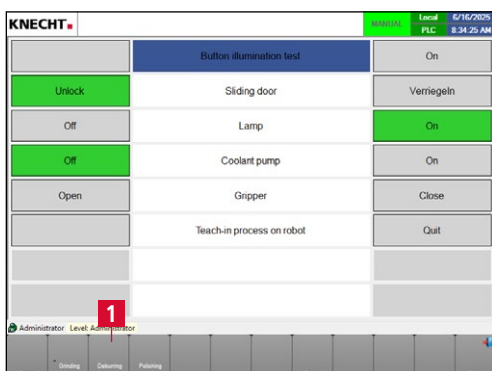

Figure 6-8 Manual functions

In the general manual functions, select the touch panel field **“Deburring unit”** (6-8/1) to access the specific manual functions of the deburring unit (6-9).

6. Commissioning



Figure 6-9 Manual functions "Deburring unit"

In "Deburring unit – Drive", select touch panel field "On" (6-9/1) to switch on the deburring unit.

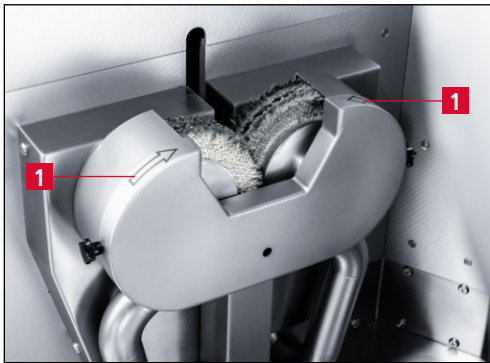

Figure 6-10 Checking the rotating direction

Check the direction of rotation of the deburring rings.

The direction arrows (6-10/1) on the protection hood indicate the direction of rotating of the deburring rings.

If the direction of rotation of the deburring rings is not correct, have the phase reversed by a qualified electrician.

After ensuring the prescribed direction of rotation, turn off the grinding machine.

To do this, turn the main switch (3-9/1) to the position "0 OFF".

7. Operation



All work may only be carried out by authorized specialist personnel.

Observe the locally applicable safety and accident prevention regulations.

7.1 Switch on the grinding machine

Set the main switch (3-9/1) to the "1 ON" position. Wait for the controls to initialize. The main screen appears on the control panel (3-10/1).



Figure 7-1 Control panel

Press the "Control ON" button (7-1/1) to activate the control system. If activation was successful, the "Control ON" button will light up continuously.

7.2 Grinding hand knives

7.2.1 Loading the knife magazines



Figure 7-2 Knife magazine

Place the hand knives (7-2/1) outside the machine as vertically as possible in both knife magazines.

Loading begins in the first row from left to right and continues in the second row from right to left. This alternating pattern is repeated until the end (see direction indicators on the knife magazines (7-2/2)).

NOTE

As shown in Figure 7-2, place the knives starting with the first row on the left (7-2/2), as the grinding program starts at this position.

7. Operation

ATTENTION

The hand knives must be cleaned before they are placed in the knife magazine.

The cutting edge must face away from the machine towards the operator.

The knife handle must stand upright, otherwise it may collide with the knife gripper.

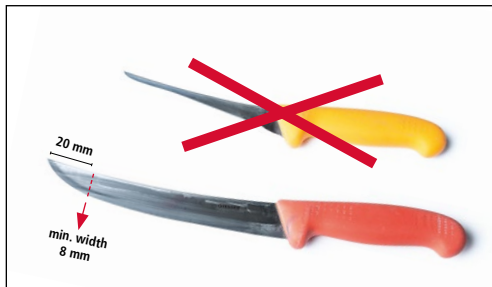

Figure 7-3 Knife width

The knife blade must be at least 70 mm and no more than 270 mm long.

Additionally, the knife blade must be at least 8 mm wide, measured 20 mm from the tip of the knife (see Figure 7-3).

7.2.2 Move the knife magazines into the grinding machine



Figure 7-4 Moving the knife magazines into the grinding machine

Open the sliding door.

Move the knife magazines (7-4/1) into the grinding machine.

Close the sliding door.

7. Operation

7.2.3 Grinding hand knives



Figure 7-5 Control panel

Press the "Start/Stop" button (7-5/1).

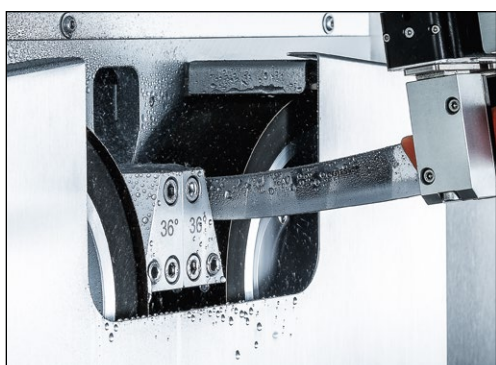

Figure 7-6 Grinding hand knives

The grinding program runs automatically.

The knife gripper removes a hand knife from the magazine, measures the knife profile, sharpens the left and right side of the cutting edge, deburrs and polishes the cutting edge, checks the sharpness (optional) and finally returns the knife to the magazine.

This process is repeated until the knife magazines have been fully processed.

ATTENTION

After sharpening, deburring and polishing the knives must be cleaned and disinfected.

7. Operation

7.3 Replacing the wet-grinding belts



For all work on the hand knife sharpening machine, observe the locally applicable safety and accident prevention regulations as well as instructions in the "Safety" and "Important notes" section of the operating instructions.

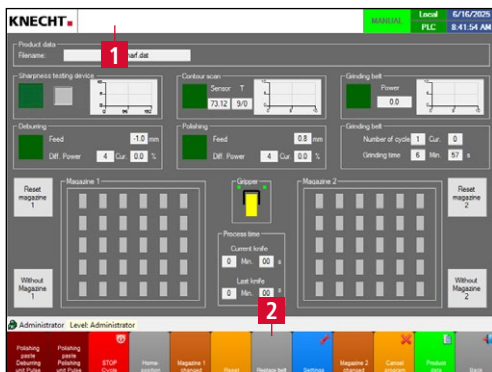

Figure 7-7 Main screen

After a predefined time, the message (7-7/1) "Replace the grinding belt" appears at the top left of the main screen.

Remove the knife magazines.

Close the sliding door.

Press the "Replace belt" touch panel field (7-7/2) for 2 seconds.



Figure 7-8 Removing the belt protection hood

The gripper (7-8/1) grabs the belt protection hood (7-8/2) and places it on the right side.

The wet-grinding belts are released automatically.

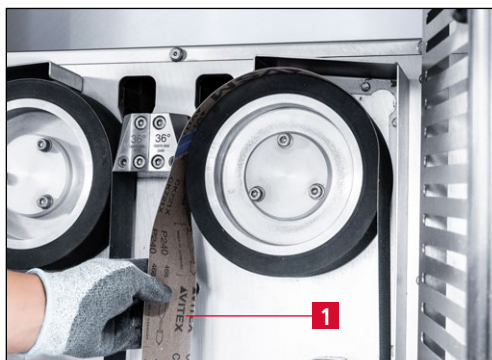

Figure 7-9 Replacing the wet-grinding belts

Open the sliding door.

Remove the used grinding belts (7-9/1) and then attach the new ones.

Close the sliding door.

7. Operation



Figure 7-10 Closing the belt protection hood

Press the **“Replace belt”** touch panel field (7-7/2) again for 2 sec. to allow the gripper to close the belt protection hood.

The grinding belts are tensioned automatically.

NOTE

The wet-grinding belts wear unevenly. It is therefore recommended to turn each belt once before replacing it with a new one.

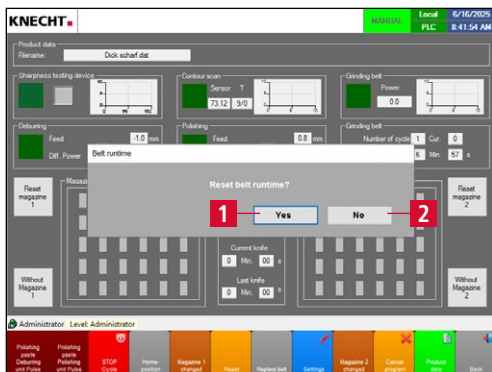

Figure 7-11 “Reset belt runtime?” message

When closing the belt protection hood, the message “Reset belt runtime?” appears on the main screen.

Answer the question with **“Yes”** (7-11/1), if the grinding belt has been replaced or turned.

If the belt protection hood was only opened to assess the grinding belts, answer the question with **“No”** (7-11/2).

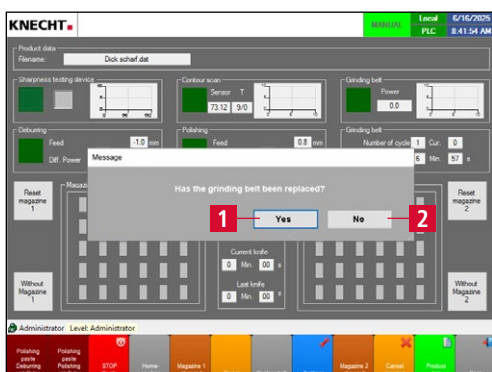

Figure 7-12 “Has the grinding belt replaced?” message

If the first message was answered with “Yes” (7-11/1), the message “Has the grinding belt been replaced?” appears.

Answer the question with **“Yes”** (7-12/1), if a new wet-grinding belt has been attached.

If the grinding belt was only turned, answer the message with **“No”** (7-12/2).

7. Operation

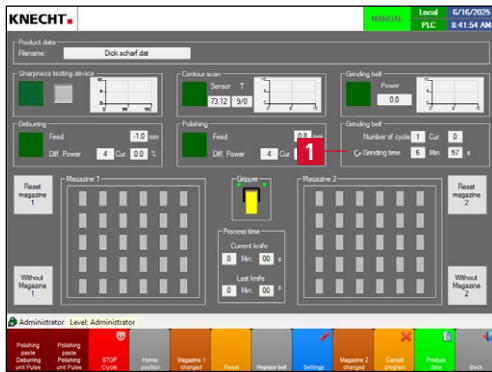

Figure 7-13 Main screen

If the grinding belts were turned successfully, an arrow will appear on the main screen near the grinding time (7-13/1).

NOTE

After the wet-grinding belts have been replaced or turned, a test run must be carried out. If the machine behaves unusually, it must be taken out of operation and the fault rectified.

ATTENTION

If new wet-grinding belts have been fitted, the message must be answered with "Yes" (7-12/1).

After a grinding belt has been changed, the machine starts the grinding process in a higher position. This ensures that less material is removed from the knife.

Only original abrasives from KNECHT Maschinenbau GmbH are permitted to be used.

KNECHT Maschinenbau GmbH assumes no responsibility for the use of non-original abrasives.

7. Operation

7.3.1 Adjusting the belt movement

NOTE

The grinding belts must be adjusted so that they protrude approx. 3 mm to the front beyond the contact disc.



Figure 7-14 Ball handle for belt adjustment

The belt adjustment is carried out using the ball handle (7-14/1) supplied.

Open the sliding door.



Figure 7-15 Belt adjustment

The belt adjustment is located below the grinding belts.

To adjust the right wet-grinding belt, place the ball handle (7-15/1) on the adjustment pin.

Then turn until the right wet-grinding belt protrudes approx. 3 mm beyond the contact disc.

Remove the ball handle from the right adjustment pin and place it on the left (7-15/2).

Then turn until the left wet-grinding belt protrudes approx. 3 mm beyond the contact disc.

NOTE

Clockwise rotation = the wet-grinding belt moves forward

Counterclockwise rotation = the wet-grinding belt moves back.

7. Operation

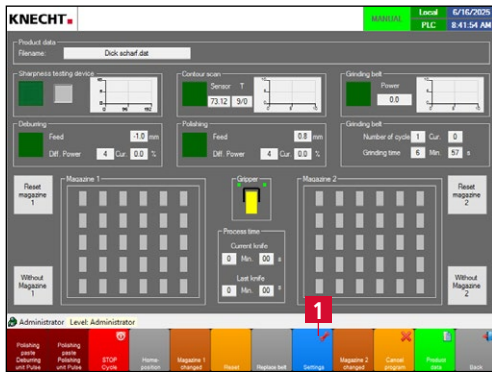

Figure 7-16 Main screen

Always perform a test run after adjusting the grinding belts.

Close the sliding door.

On the main screen, use the touch panel field **“Settings”** (7-16/1) to switch to the “Settings” display (7-17).

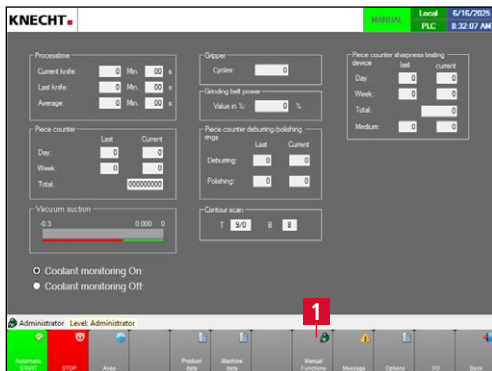

Figure 7-17 Settings

Use the touch panel field **“Manual functions”** (7-17/1) to switch to the “Manual functions” display (7-18).

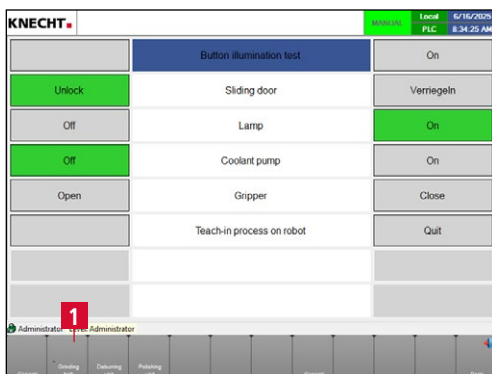

Figure 7-18 Manual functions

Press the **“Grinding belt”** touch panel field (7-18/1) to access the manual functions of the wet-grinding belts.

7. Operation

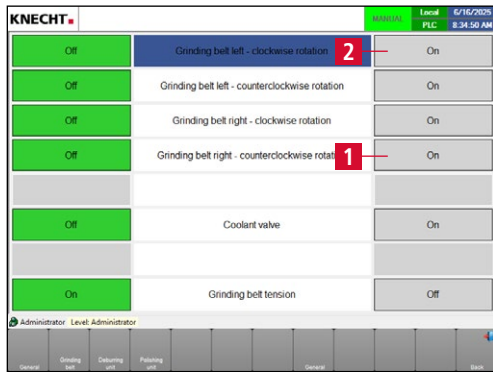

Figure 7-19 Manual functions "Grinding belt"

Switch on the right wet-grinding belt "Grinding belt right – counterclockwise rotation" using touch panel field **"On"** (7-19/1).

Switch on the left wet-grinding belt "Grinding belt left – clockwise rotation" using touch panel field **"On"** (7-19/2).

7. Operation

7.4 Replacing the deburring rings



For all work on the hand knife sharpening machine, observe the locally applicable safety and accident prevention regulations as well as instructions in the "Safety" and "Important notes" section of the operating instructions.

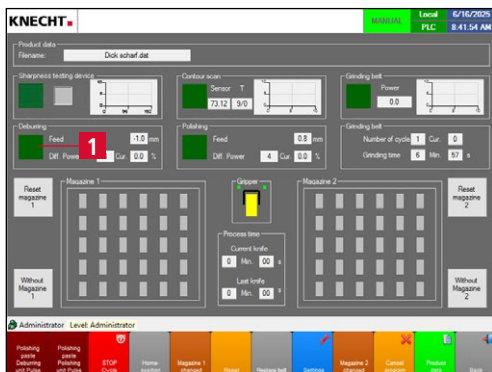

Figure 7-20 Main screen

Close the sliding door.

Press the green **"Deburring"** touch panel field (7-20/1) on the main screen for 2 seconds until the "Deburring" window (7-21) opens.



Figure 7-21 Deburring – Replacing the deburring rings

Select the **"Replacing deburring / polishing rings"** touch panel field (7-21/1).

The deburring rings are moved to the change position.



Figure 7-22 Loosening the star handles

Open the sliding door.

Remove the knife magazines.

Loosen the two star handles (7-22/1) of the protection hood.

7. Operation

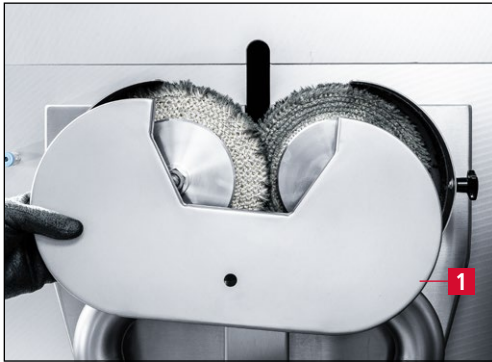

Figure 7-23 Removing the protection hood

Remove the protection hood (7-23/1) and clean it under running water.

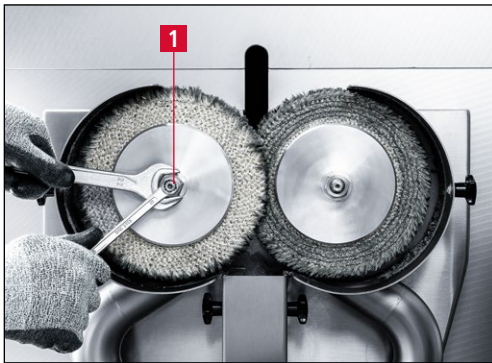

Figure 7-24 Unscrewing the left clamping nut

Loosen the clamping nut (7-24/1) of the left deburring ring **clockwise** using an AF 22 mm open-end wrench. Fix the shaft with the AF 10 mm open-end wrench.

Unscrew the nut.

NOTE

**The left shaft has a left-hand thread.
To loosen the clamping nut, turn clockwise.**



Figure 7-25 Removing the flange washer

Remove flange washer (7-25/1).

7. Operation

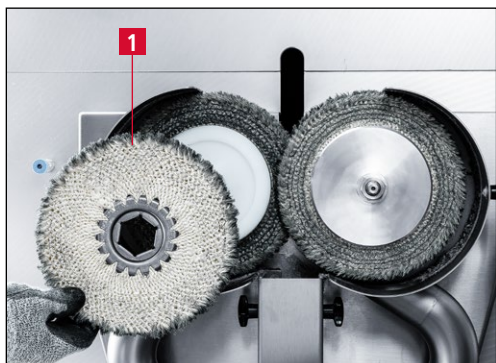

Figure 7-26 Removing the used deburring ring

Remove the used deburring ring (7-26/1).

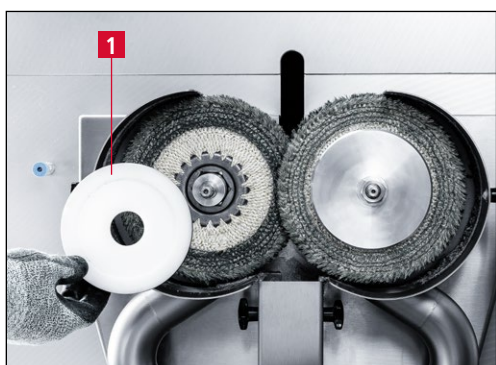

Figure 7-27 Removing the intermediate flange

Remove the intermediate flange (7-27/1).



Figure 7-28 Unscrewing the right clamping nut

Open the clamping nut (7-28/1) of the right deburring ring **counterclockwise** using an AF 22 mm open-end wrench. Secure the shaft with an AF 10 mm open-end wrench.

Unscrew the nut.

NOTE

The right shaft has a right-hand thread. To loosen the clamping nut, turn counterclockwise.

7. Operation



Figure 7-29 Removing the flange washer

Remove flange washer (7-29/1).



Figure 7-30 Removing the used deburring ring

Remove the used deburring ring (7-30/1).



Figure 7-31 Removing the intermediate flange

Remove the intermediate flange (7-31/1).

7. Operation

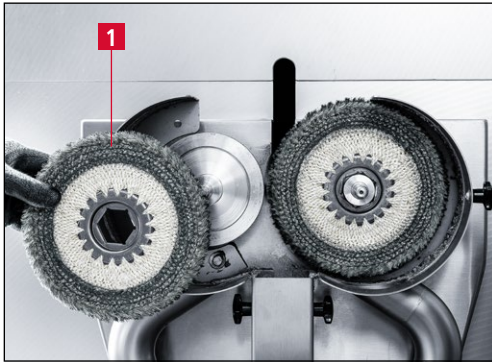

Figure 7-32 Replacing the deburring rings

Remove the left deburring ring (7-32/1).

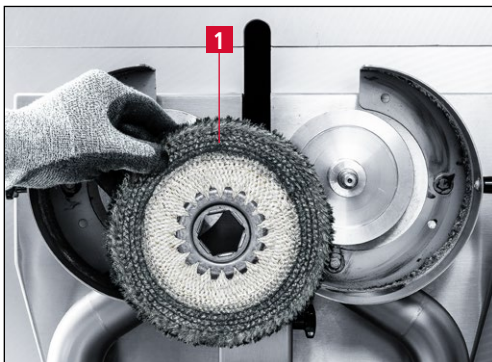

Figure 7-33 Replacing the deburring rings

Remove the right deburring ring (7-33/1).

Mount the new deburring rings and the protection hood in reverse order.

Close the sliding door.

Then adjust the deburring rings (see Chapter 7.4.1).

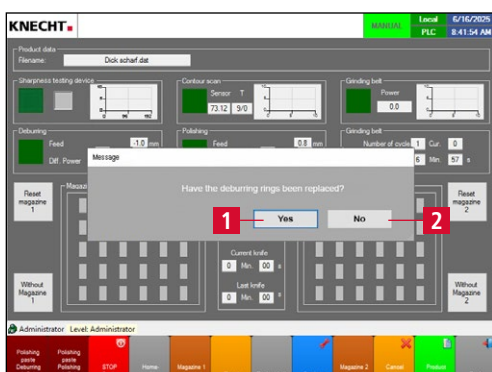

Figure 7-34 Message "Have the deburring rings been replaced?"

After closing the protection hood, the message "Have the deburring rings been replaced?" appears on the main screen.

Answer "Yes" (7-34/1) if the deburring rings have been replaced.

If the protection hood was only opened to check the deburring rings, answer the question with "No" (7-34/2).

ATTENTION

If the deburring rings have been replaced, the message must be answered with "Yes" (7-34/1).

7. Operation

NOTE

After replacing the deburring rings, a test run must be carried out. If the machine behaves unusually, it must be taken out of operation and the fault rectified.

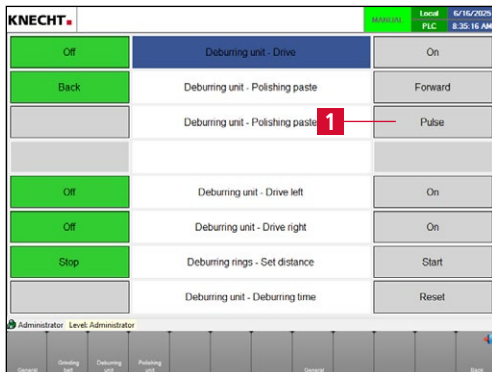

Figure 7-35 Applying the polishing paste

During the test run under “Manual functions” – “Deburring unit” (see Chapter 8.4.3), press the “Pulse” touch panel field (7-35/1) five times to ensure that there is sufficient paste on the deburring rings.

ATTENTION

Only original abrasives from KNECHT Maschinenbau GmbH are permitted to be used.

KNECHT Maschinenbau GmbH assumes no responsibility for the use of non-original abrasives.

Using non-original deburring rings can result in damage to the knife and the grinding machine.

7.4.1 Adjusting the deburring rings

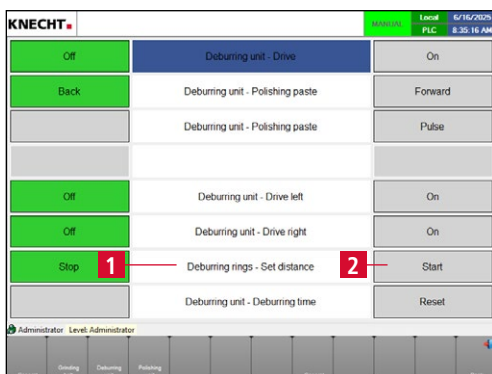

Figure 7-36 Adjusting the deburring rings

The deburring rings are automatically adjusted so that the front ring touches the metal flange of the neighboring deburring ring.

The adjustment is made automatically after the grinding program has started or manually via “Manual functions” – “Deburring unit” – “Deburring rings – Set distance” (7-36/1).

Use the touch panel field “Start” (7-36/2) to start adjusting the distance of the deburring rings.

7. Operation

7.5 Replacing the polishing rings



CAUTION

For all work on the hand knife sharpening machine, observe the locally applicable safety and accident prevention regulations as well as instructions in the "Safety" and "Important notes" section of the operating instructions.

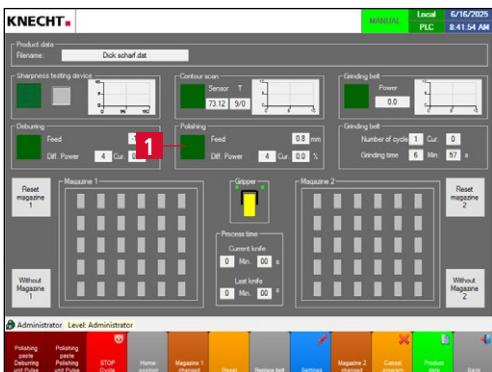

Figure 7-37 Main screen

Close the sliding door.

Press the green **"Polishing"** touch panel field (7-37/1) on the main screen for 2 seconds until the "Deburring" window (7-38) opens.

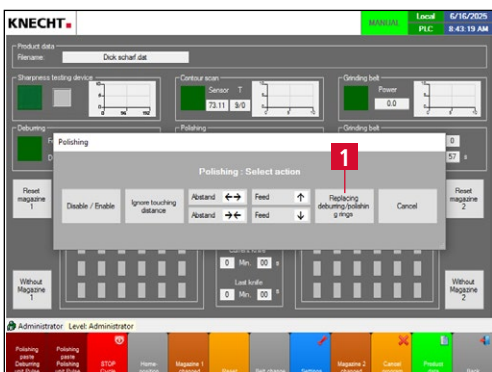

Figure 7-38 Polishing – Replacing the polishing rings

Select the **"Replacing deburring / polishing rings"** touch panel field (7-38/1).

The polishing rings are moved to the change position.

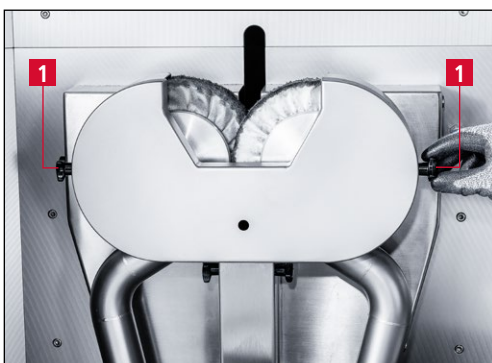

Figure 7-39 Loosening the star handles

Open the sliding door.

Remove the knife magazines.

Loosen the two star handles (7-39/1) of the protection hood.

7. Operation

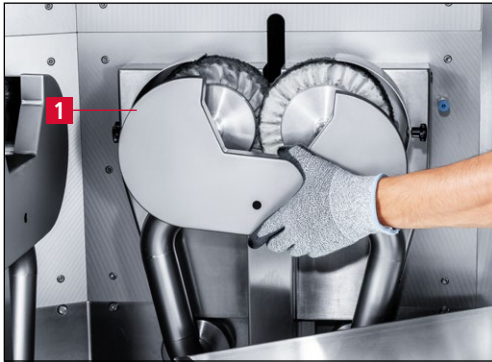

Figure 7-40 Removing the protection hood

Remove the protection hood (7-40/1) and clean it under running water.

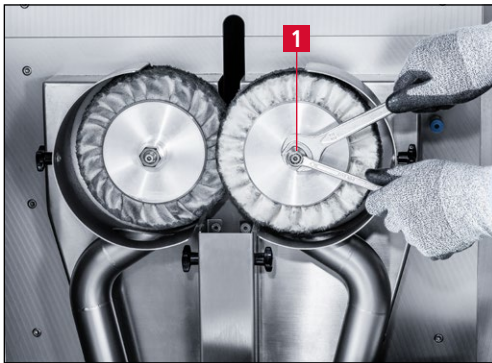

Figure 7-41 Unscrewing the right clamping nut

Open the clamping nut (7-41/1) of the right polishing ring **counterclockwise** using an AF 22 mm open-end wrench. Secure the shaft with an AF 10 mm open-end wrench.

Unscrew the nut.

NOTE

The right shaft has a right-hand thread. To loosen the clamping nut, turn counterclockwise.

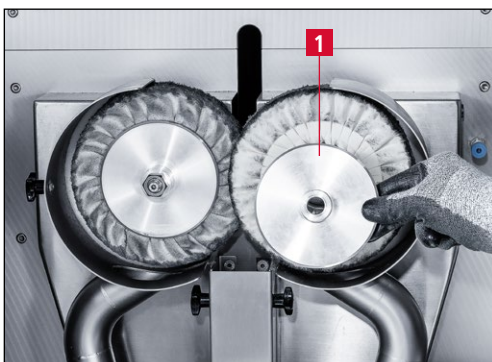

Figure 7-42 Removing the flange washer

Remove flange washer (7-42/1).

7. Operation

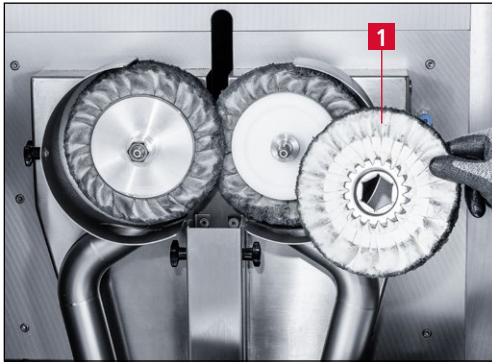

Figure 7-43 Removing the used polishing ring

Remove the used polishing ring (7-43/1).

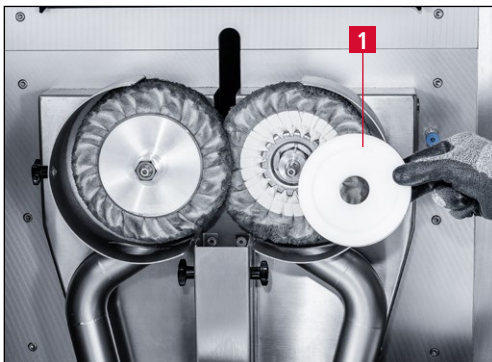

Figure 7-44 Removing the intermediate flange

Remove the intermediate flange (7-44/1).



Figure 7-45 Unscrewing the left clamping nut

Open the clamping nut (7-45/1) of the left polishing ring **clockwise** using an AF22 mm open-end wrench. Secure the shaft with an AF10 mm open-end wrench.

Unscrew the nut.

NOTE

The left shaft has a left-hand thread. To loosen the clamping nut, turn clockwise.

7. Operation

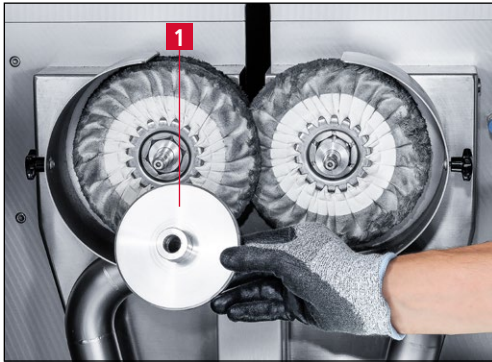

Figure 7-46 Removing the flange washer

Remove flange washer (7-46/1).

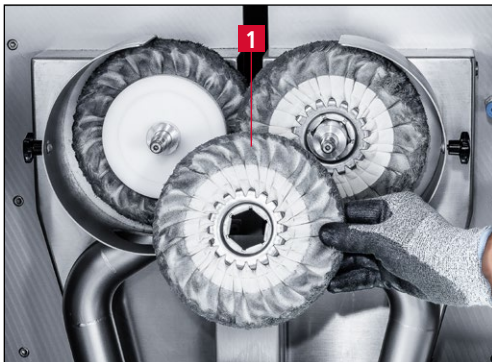

Figure 7-47 Removing the used polishing ring

Remove the used polishing ring (7-47/1).



Figure 7-48 Removing the intermediate flange

Remove the intermediate flange (7-48/1).

7. Operation

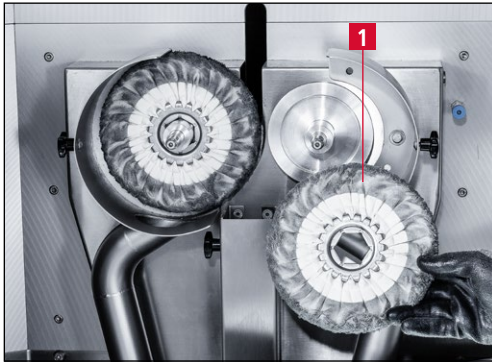

Figure 7-49 Removing the right polishing ring

Remove the right polishing ring (7-49/1).



Figure 7-50 Replacing the polishing rings

Remove the left polishing ring (7-50/1).

Mount the new polishing rings and the protection hood in reverse order.

Close the sliding door.

Then adjust the polishing rings (see Chapter 7.5.1).

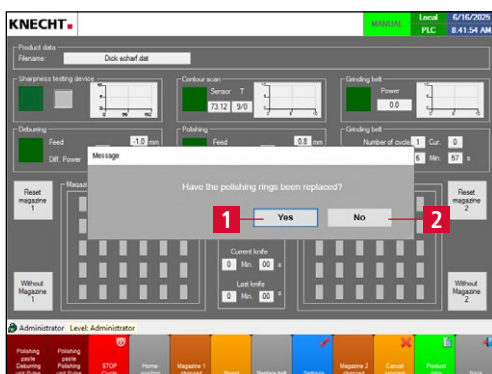

Figure 7-51 Message "Have the polishing rings been replaced?"

After closing the protection hood, the message "Have the polishing rings been replaced?" appears on the main screen.

Answer **"Yes"** (7-51/1) if the polishing rings have been replaced.

If the protection hood was only opened to check the polishing rings, answer the question with **"No"** (7-51/2).

ATTENTION

If the polishing rings have been replaced, the message must be answered with "Yes" (7-51/1).

7. Operation

NOTE

After replacing the polishing rings, a test run must be carried out. If the machine behaves unusually, it must be taken out of operation and the fault rectified.

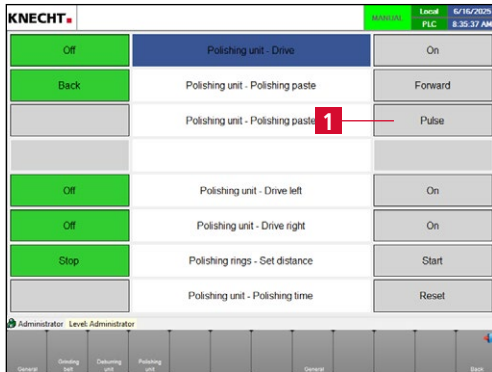

Figure 7-52 Applying the polishing paste

During the test run under “Manual functions” – “Polishing unit” (see Chapter 8.4.4), press the “Pulse” touch panel field (7-52/1) five times to ensure that there is sufficient paste on the polishing rings.

ATTENTION

Only original abrasives from KNECHT Maschinenbau GmbH are permitted to be used.

KNECHT Maschinenbau GmbH assumes no responsibility for the use of non-original abrasives.

Using non-original polishing rings can result in damage to the knife and the grinding machine.

7.5.1 Adjusting the polishing rings

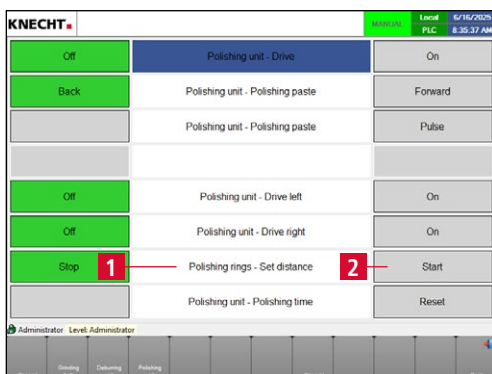

Figure 7-53 Adjusting the polishing rings

The polishing rings are automatically adjusted so that the front ring touches the metal flange of the neighboring polishing ring.

The adjustment is made automatically after the grinding program has started or manually via “Manual functions” – “Polishing unit” – “Polishing rings – Set distance” (7-53/1).

Use the touch panel field “Start” (7-53/2) to start adjusting the distance of the polishing rings.

7. Operation

7.6 Replacing the polishing pastes

7.6.1 Replacing the polishing paste of the deburring unit

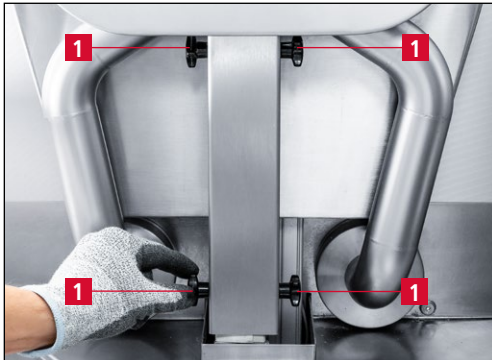

Figure 7-54 Opening the cover

Open the sliding door.

Remove the knife magazines.

To replace the polishing paste of the deburring unit, loosen the four star handles (7-54/1) on the polishing paste cover.



Figure 7-55 Removing the cover

Remove the cover (7-55/1).



Figure 7-56 Replacing the polishing paste

Remove the used paste and replace it with a new paste (7-56/1).

Refit the cover (7-55/1) and secure with the four star handles (7-54/1).

Close the sliding door.

ATTENTION

Only original abrasives from KNECHT Maschinenbau GmbH are permitted to be used.

7. Operation

ATTENTION

KNECHT Maschinenbau GmbH assumes no responsibility for the use of non-original abrasives.

7.6.2 Replacing the polishing paste of the polishing unit



Figure 7-57 Removing the collection container

Open the sliding door.

Remove the knife magazines.

To replace the polishing paste of the polishing unit, first remove the collection container (7-57/1).



Figure 7-58 Opening the cover

Then loosen the four star handles (7-58/1) on the polishing paste cover.



Figure 7-59 Removing the cover

Remove the cover (7-59/1).

7. Operation



Figure 7-60 Replacing the polishing paste

ATTENTION

Remove the used paste and replace it with a new paste (7-60/1).

Refit the cover (7-59/1) and secure it with the four star handles (7-58/1).

Refit the collection container (7-57/1).

Close the sliding door.

Only original abrasives from KNECHT Maschinenbau GmbH are permitted to be used.

KNECHT Maschinenbau GmbH assumes no responsibility for the use of non-original abrasives.

7. Operation

7.7 Replacing the test medium of the sharpness testing device



Figure 7-61 Opening the sharpness testing device

Open the door of the sharpness testing device (7-61/1) on the left side of the machine.



Figure 7-62 Removing the used test medium

Turn the knurled nut (7-62/1) of the upper coil **counterclockwise** and remove it.

Remove the cover from the coil and take out the used test medium including the triangular core.

Turn the knurled nut (7-62/1) of the lower coil **counterclockwise** and remove it.

Place the triangular core from the lower coil onto the upper coil.

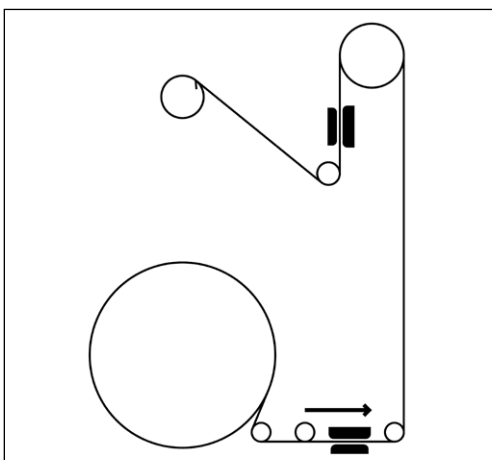

Figure 7-63 Inserting the test medium

Insert new test medium into the lower coil and thread in as specified (see Figure 7-63).

Reattach the covers of the upper and lower coils and secure with the knurled nuts.

Calibrate the sharpness testing device (see Chapter 7.7.1).

7. Operation

7.7.1 Calibrating the sharpness testing device

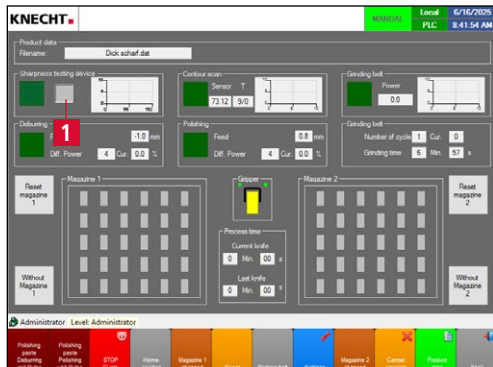

Figure 7-64 Main screen

Open the settings page of the sharpness testing device via the touch panel field (7-64/1).

NOTE

The test medium must not be under tension.

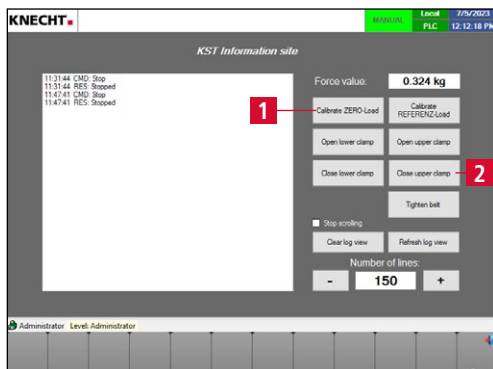

Figure 7-65 Calibrating "ZERO-Load"

Press the **"Calibrate ZERO-Load"** touch panel field (7-65/1).

The sharpness testing device is now calibrated to "0".

Secure the test medium using the **"Close upper clamp"** touch panel field (7-65/2).



Bild 7-66 Removing calibration weight

Remove the calibration weight (7-66/1) from the holder.

7. Operation

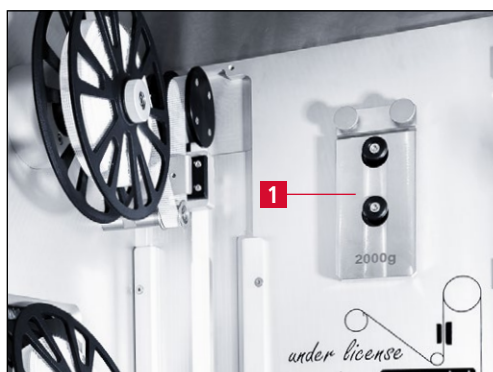
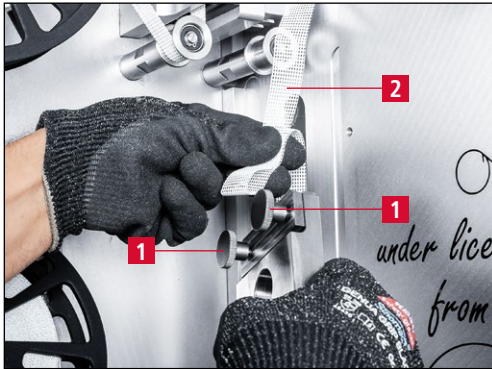

Figure 7-67 Attaching the test medium to the calibration weight

NOTE

Open the two knurled screws (7-67/1).

Pull the test medium (7-67/2) slightly forwards from the rear, bend it, then insert it into the slot of the calibration weight.

Secure with the knurled screws (7-67/1).

The test medium must be secured in place by pressing the "Close upper clamp" touch panel field (7-65/2).

Otherwise the calibration weight will fall down and calibration cannot be performed.

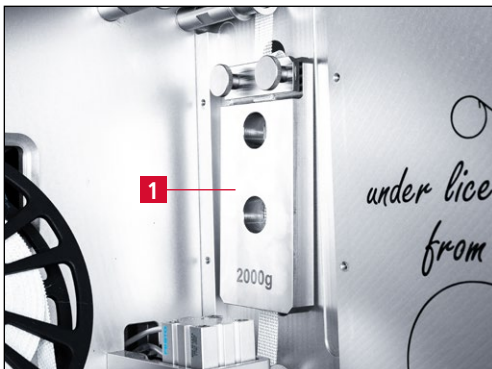

Figure 7-68 Calibration weight

Make sure that the weight (7-68/1) hangs freely and is not resting on anything.

ATTENTION

A calibration weight that is not hanging freely can lead to incorrect calibration and therefore inaccurate sharpness test results.

7. Operation

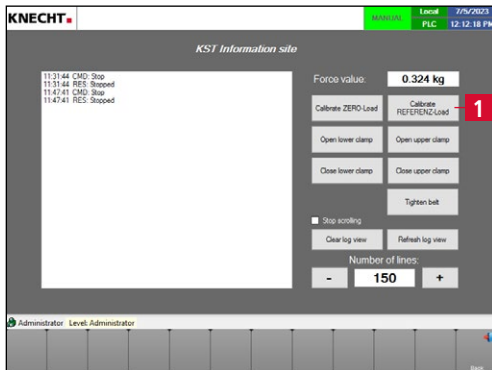

Figure 7-69 „CALIBRATING THE “REFERENCE-LOAD”

Press the „**Calibrate REFERENCE-Load**” touch panel field (7-69/1).

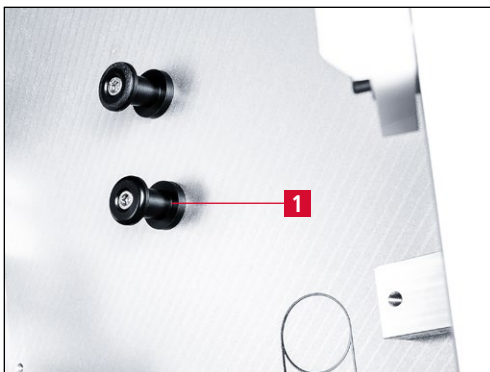

Figure 7-70 Calibration weight holder

After calibration, remove the weight and hang it on the holder (7-70/1).

Close the door of the sharpness testing device.

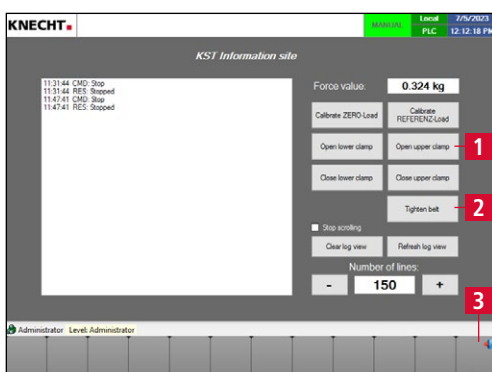

Figure 7-71 Settings sharpness testing device

Use the “**Open upper clamp**” touch panel field (7-71/1) to release the test medium and then tighten the test medium with “**Tighten belt**” (7-71/2).

Press “**Back**” (7-71/3) to return to the main screen.

8. Control

8.1 Main screen

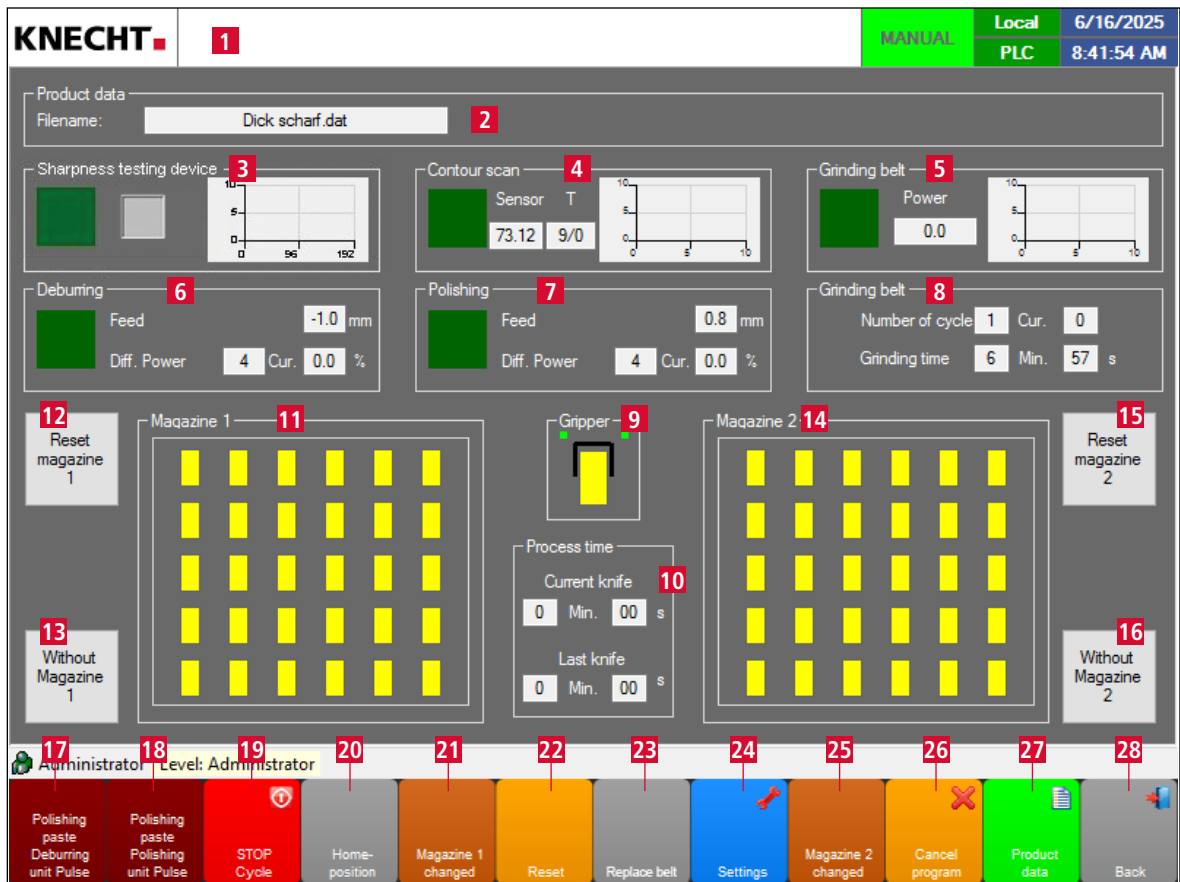

Figure 8-1 Main screen

- 1 Errors and general messages (double-tap to open message texts)
- 2 Product data (loaded product data)
- 3 Sharpness testing device (optional) (activate/deactivate using the green button; tap the diagram to open it)
- 4 Contour capture (tap the diagram to open it)
- 5 Grinding belt (activate the wet-grinding belts using the green button; tap the diagram to open it; performance)
- 6 Deburring (feed and diff. power, activate/deactivate the deburring unit using the green button)
- 7 Polishing (feed and diff. power, activate/deactivate the polishing unit using the green button)
- 8 Grinding belt (number of cycles and grinding time, wet-grinding belt rotated)
- 9 **"Gripper"**: Tapping the gripper symbol opens/closes knife gripper
- 10 Processing duration (current and last knife)
- 11 Magazine 1
- 12 **"Reset magazine 1"**: empty knife magazine 1
- 13 **"Without Magazine 1"**: do not process magazine 1 (activate/deactivate)

8. Control

- 14 Magazine 2
- 15 **“Reset Magazine 2”**: empty knife magazine 2
- 16 **“Without Magazine 2”**: do not process magazine 2 (activate/deactivate)
- 17 **“Polishing paste Deburring unit Pulse”**: feed polishing paste Deburring unit one time
- 18 **“Polishing paste Polishing unit Pulse”**: feed polishing paste Polishing unit one time
- 19 **“STOP cycle”**: stop processing after the currently active knife
- 20 **“Homeposition”**: run machine to initial position
- 21 **„Magazine 1 changed”**: tap once to add one knife to the magazine; press and hold for 2 sec to refill the magazine
- 22 **„Reset”**: reset control
- 23 **„Belt change”**: clears the “Replace grinding belt” message (press for 5 sec)
- 24 **„Settings”**: switches to the “Settings” display
- 25 **„Magazine 2 changed”**: tap once to add one knife to the magazine; press and hold for 2 sec to refill the magazine
- 26 **„Cancel program”**: cancel current knife program and begin grinding process from beginning
- 27 **„Product data”**: load different grinding programs (for product file loaded, see (8-1/2))
- 28 **“Back”**: switch to the previous display or close user interface

NOTE

When the key-operated switch (3-10/7) is on position “1”, the knife gripper (3-3/3) can be activated even when the door is open.

Touch panel fields “Polishing paste Deburring unit Pulse” (8-1/17) and “Polishing paste Polishing unit Pulse” (8-1/18) only work in automatic mode while the deburring and polishing units are active.

Removing the knife magazine resets the machine.



CAUTION

The key-operated switch may only be operated by specialized trained personnel.

If the key-operated switch (3-10/7) is on position “1”, there is a pinching hazard from the knife gripper.

8. Control

8.2 Settings

Settings other than the basic “Start” and “Stop” functions of the machine are made in the main menu under **“Settings”** (8-1/24).

ATTENTION

Changes to the settings can damage the machine.

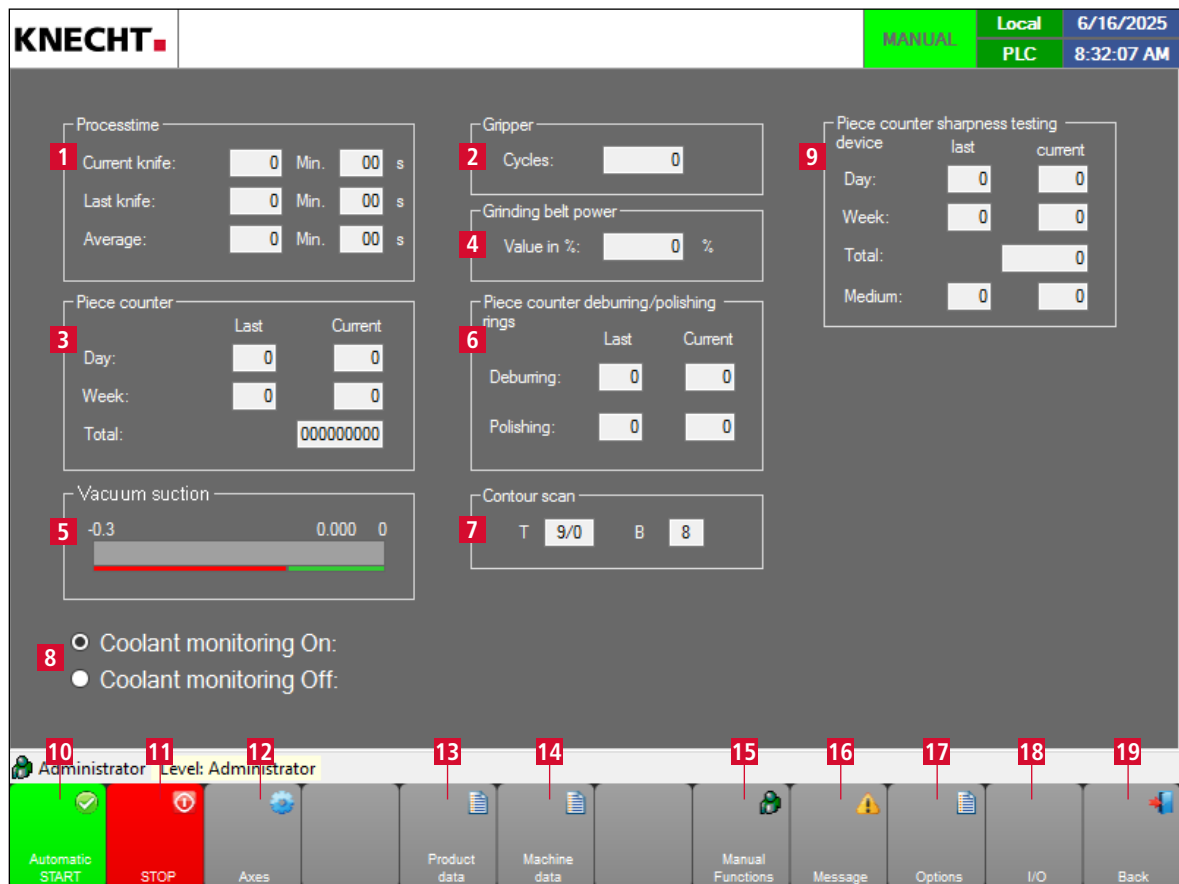

Figure 8-2 Settings

- 1 Processing period (current knife, last knife and average in mins/secs)
- 2 Gripper (Cycles)
- 3 Piece counter (Day, Week, Total)
- 4 Grinding belt power (Value in %)
- 5 Vacuum suction
- 6 Piece counter deburring and polishing rings
- 7 Contour capture
- 8 Coolant monitoring on/off
- 9 Sharpness testing device (optional)
- 10 **“Automatic START”**: start grinding program
- 11 **„STOP“**: stop processing

8. Control

- 12 **„Axes“**: axes menu
- 13 **„Product data“**: product data, settings, see Chapter 8.3.2
- 14 **“Machine data“**: display/edit factory-set machine data
- 15 **“Manual functions“**: permits manual operation of the machine; see Chapter 8.4
- 16 **“Message texts“**: displays all error messages continuously (number, frequency, start; see Chapter 8.5)
- 17 **„Options“**: change language etc; see Chapter 8.6
- 18 **„I/O“**: status Beckhoff components
- 19 **“Back“**: switch to the previous display

8. Control

8.3 Product data

8.3.1 Loading the product data

In the "Product data" display, you can load programs you have created yourself, in which, for example, the cycle numbers have been adjusted.



Improper changes to the product data can result in damage to the machine and/or the knives.



Use the "Product data" touch panel field (8-3/1) to switch to the "Product data" display (8-4).

Figure 8-3 Main screen

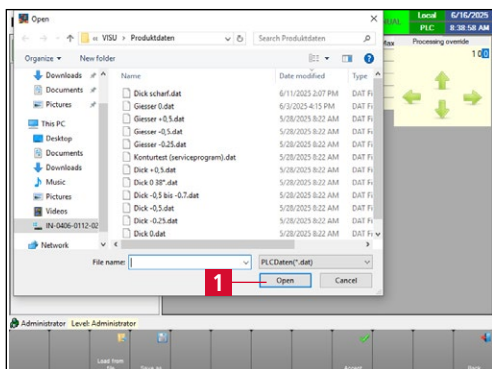

After switching on, the product from the last operation is automatically activated.

To load a new product, select the corresponding file.

Load the new product by double-clicking or using the "Open" touch panel field (8-4/1).

Figure 8-4 Product data

8. Control

8.3.2 Changing the product data

Product data can be changed, for example, to adjust the cycle numbers.

ATTENTION

Improper changes to the product data can result in damage to the machine and/or the knives.

Touch panel field **„Settings“** (8-5/1) switches to the **„Settings“** display (8-6).

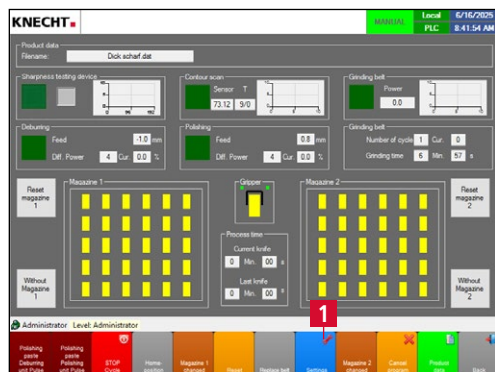

Figure 8-5 Main screen

Touch panel field **„Product data“** (8-6/1) switches to the **„Product data“** display (8-7).



Figure 8-6 Settings

Select the desired parameter in the menu tree and change the value.

Save with **„Accept“** (8-7/1).

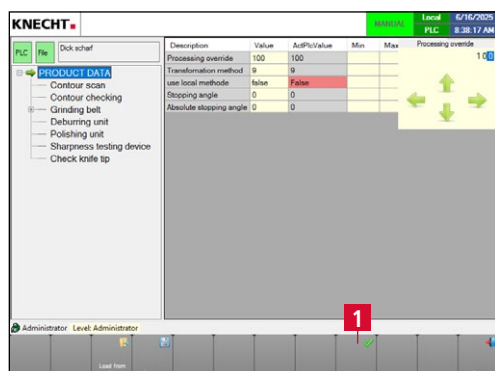

Figure 8-7 Changing the product data

8. Control

8.4 Manual functions

The manual functions permit manual operation of the machine. Various functions of the grinding machine, such as adjusting the wet-grinding belt and the polishing paste, as well as test runs, can be carried out individually.

They are accessed via the main menu **“Settings”** (8-1/24), followed by **“Manual functions”** (8-2/14). Various functions of the grinding machine can be operated individually.

ATTENTION

Buttons highlighted in green are active. Buttons highlighted in gray are inactive.

NOTE

All functions are only active when the sliding door is closed.

8.4.1 General

If the **“Manual functions”** submenu (8-2/14) has been called up, the display first changes to the general manual functions (8-8).

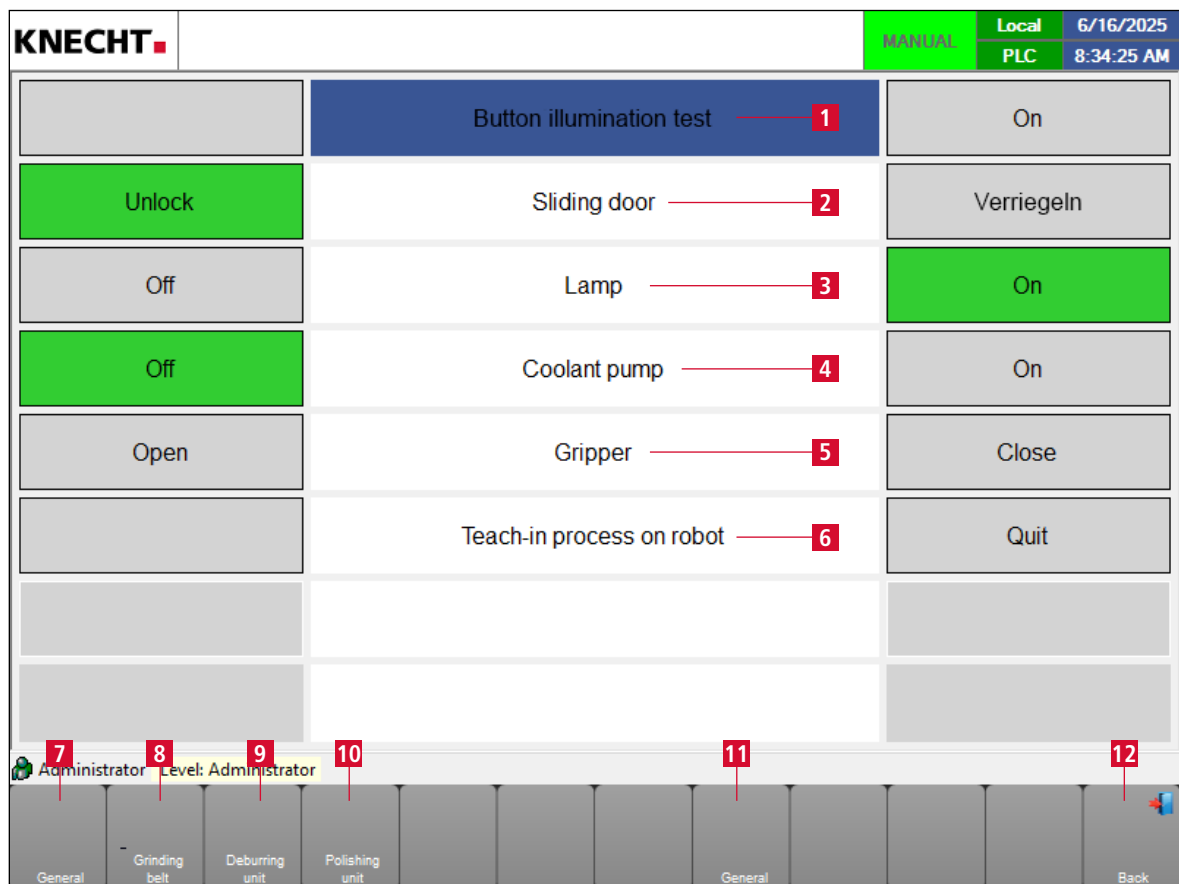

Figure 8-8 Manual functions “General”

8. Control

- 1 Button illumination test
- 2 Unlock/lock sliding door
- 3 Switch machine lamps on/off
- 4 Switch the coolant pump on/off
- 5 Open/close the gripper
- 6 Stop teaching process in robot
- 7 **“General”** (current display)
- 8 **„Grinding belt“**: see Chapter 8.4.2
- 9 **„Deburring unit“**: see Chapter 8.4.3
- 10 **“Polishing unit“**: see Chapter 8.4.4
- 11 **„General“**: see Chapter 8.4.5
- 12 **“Back“**: switch to the previous display

8.4.2 Grinding belt

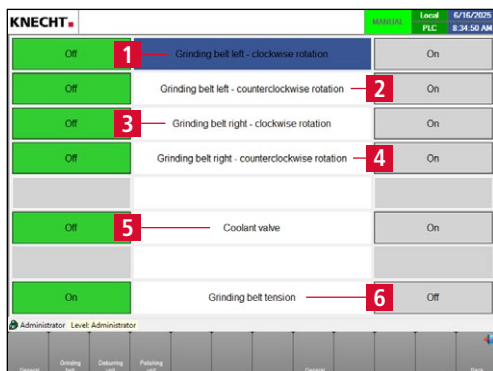

Figure 8-9 Manual functions “Grinding belt”

- 1 Grinding belt left – clockwise rotation on/off
- 2 Grinding belt left – counterclockwise rotation on/off
- 3 Grinding belt right – clockwise rotation on/off
- 4 Grinding belt right – counterclockwise rotation on/off
- 5 Coolant valve on/off
- 6 Belt tension on/off

8.4.3 Deburring unit



Figure 8-10 Manual functions “Deburring unit”

- 1 Deburring unit – Drive on/off
- 2 Deburring unit – Polishing paste forwards/backwards
- 3 Deburring unit – Polishing paste Pulse
- 4 Deburring unit – Drive left on/off
- 5 Deburring unit – Drive right on/off
- 6 Deburring rings – Set distance start/stop
- 7 Deburring unit – Reset deburring time

8. Control

8.4.4 Polishing unit



Figure 8-11 Manual functions "Polishing unit"

- 1 Polishing unit – Drive on/off
- 2 Polishing unit – Polishing paste forwards/backwards
- 3 Polishing unit – Polishing paste Pulse
- 4 Polishing unit – Drive left on/off
- 5 Polishing unit – Drive right on/off
- 6 Polishing rings – Set distance start/stop
- 7 Polishing unit – Reset polishing time

8.4.5 General



Figure 8-12 Manual functions "General"

- 1 Suction unit internal on/off
- 2 Switch suction unit to deburring unit/polishing unit
- 3 Sealing air measuring on/off
- 4 Sealing air robot on/off

8. Control

8.5 Message texts

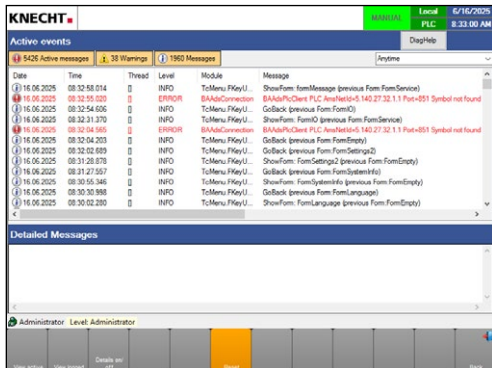

Figure 8-13 Message texts

The message texts display (8-13) is used exclusively for the detailed display of the status messages of the machine.

It provides an overview of how many errors are currently preventing the machine from operating properly. In addition, the submenu provides information about which errors have occurred and since when they have been active.

NOTE

No settings can be made in the Message Texts sub-menu. The errors also appear in the upper part of the main screen (8-1/1).

8.6 Options

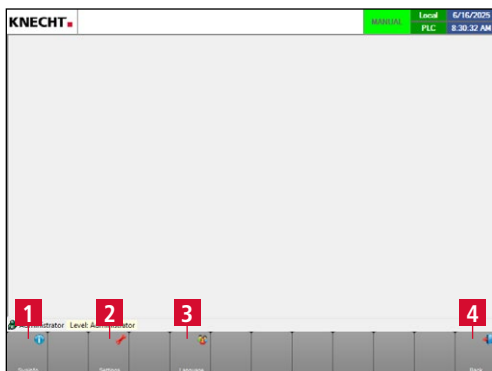

Figure 8-14 Options

- 1 **"Sysinfo"**
- 2 **"Settings"**
- 3 **"Language"**: change language (see Chapter 8.7)
- 4 **"Back"**: switch to the previous display

8. Control

8.7 Changing the language

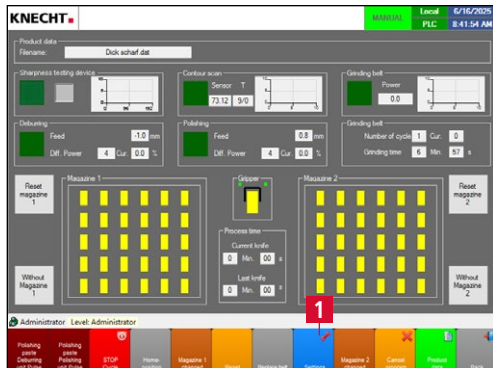

Figure 8-15 Main screen

Touch panel field **„Settings“** (8-15/1) switches to the „Settings“ display (8-16).

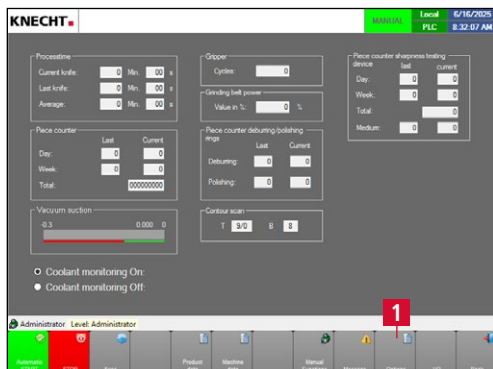

Figure 8-16 Settings

Touch panel field **„Options“** (8-16/1) switches to the „Options“ display (8-17).

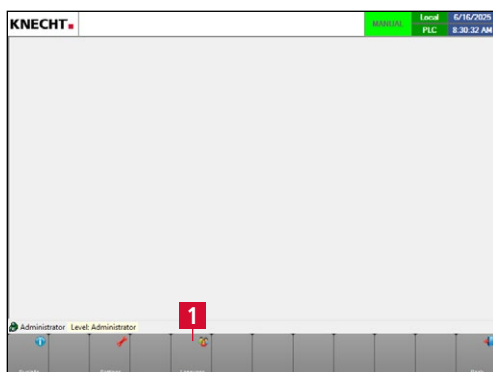

Figure 8-17 Options

Touch panel field **„Language“** (8-17/1) switches to the „Language“ display (8-18).

8. Control

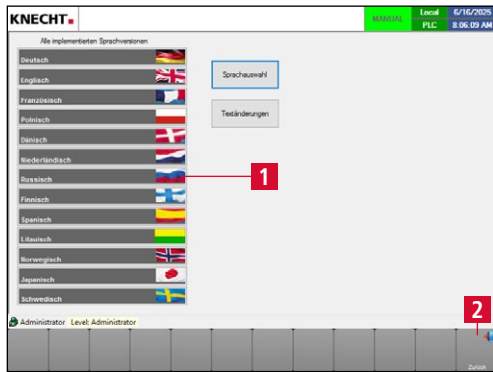

Figure 8-18 Language

The desired language is selected and automatically activated by pressing the corresponding touch panel field (8-18/1).

Each time you press **“Back”** you move one level higher in the menu; after three levels, you reach the main menu.

8. Control

8.8 Setting up an internet connection



Figure 8-19 Network connection

The machine is equipped with an ethernet port (8-19/2). A secure connection between the machine and KNECHT Maschinenbau GmbH can be established via the integrated VPN router. The connection can be activated or deactivated by the operator using the key switch on the control cabinet (8-19/1).

This connection gives the KNECHT service technician access to the control and allows him to diagnose the machine, change the software settings and upload or edit new grinding programs.

There must be an active Internet connection to initiate the connection.

NOTE

When commissioning, the VPN router is configured according to the specified IT infrastructure so that the machine communicates exclusively with KNECHT Maschinenbau GmbH via the VPN server. Any communication within the customer network is excluded. The customer network is therefore optimally protected.

In order to establish the internet connection, plug the supplied ethernet cable into the on-site network socket (RJ45) and the network port on the control cabinet (8-19/2).

9. Care and maintenance

9.1 Replacing the coolant water

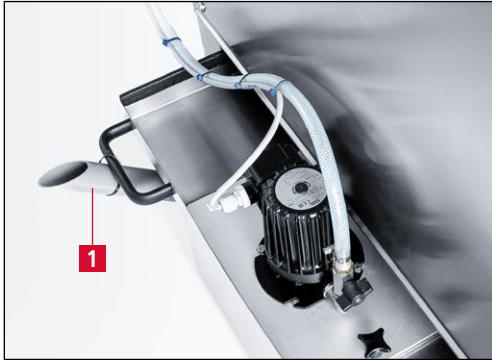

Figure 9-1 Replacing the coolant water

The cooling water has to be replaced daily and the water tray must be cleaned.

For emptying, place the pipe (9-1/1) at the rear of the water tray in a horizontal position.

The water tray must always be filled with 60l water up to 3 cm below the rim.

NOTE

Use pure tap water without additives as coolant.

ATTENTION

The machine must not be operated without coolant. Hand knives may be damaged.

9.2 Cleaning

The machine must be cleaned after each grinding operation, otherwise the grinding abrasion dries and is difficult to remove.

Clean the windows with soft cleaning cloths and window cleaning agent.

After cleaning the grinding machine, we recommend using the products listed in the Cleaning agent and lubricant table for care of the machine (see Chapter 9.2.1).

ATTENTION

The grinding machine must not be sprayed with water nor cleaned with alkaline cleaning agents. Machine components may be damaged or destroyed.

Deburring and polishing rings must not get wet, as they can only absorb the polishing paste and deburr / polish a knife properly when dry.

9. Care and maintenance

9.2.1 Cleaning agent and lubricant table

Cleaning / Lubrication work	Interflon	WÜRTH	SHELL	EXXON Mobil	OEST	AXEL Christiernsson
Cleaning and care of machine parts	Dry Clean Stainless Steel	Stainless steel care spray	Risella 917	Marcol 82	New Process Multispray	
Lubricate the grinding belt motors						Multi-purpose grease Acinol 142S
Lubricate the gripper					IXELON LT000EP	
Lubricate the sliding door	Grease MP 100		Gadus S5 V142 W0018		IXELON LT000EP	
Lubricate the deburring/polishing units				Mobilith SHC 100	Multi-purpose grease LT 190 EP	

9.2.2 Checking and cleaning the suction unit



Figure 9-2 Emptying the drawer of the suction unit

Empty the drawer of the suction unit (9-2/1) once a week.

ATTENTION

Move the drawer under the machine as far as it will go, otherwise the suction unit will not operate at full power.

9. Care and maintenance

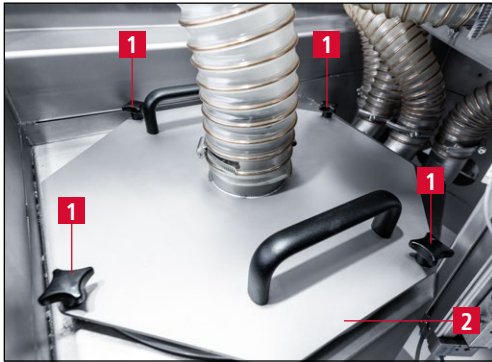

Figure 9-3 Opening the suction unit

Check the filter cartridge of the suction unit once a week.

To do this, open the door on the left side of the machine.

Open the four star handles (9-3/1) of the suction unit and remove the cover (9-3/2) using the handles.



Figure 9-4 Removing the filter cartridge

Remove the filter cartridge (9-4/1).



Bild 9-5 Cleaning the filter cartridge

Clean the filter cartridge (9-5/1) with an industrial vacuum cleaner.

NOTE

The filter cartridge may also be cleaned with water.

ATTENTION

Do not spray the filter cartridge with a high-pressure cleaner. Only install the filter cartridge when it is dry.

9. Care and maintenance

ATTENTION

Damaged filter cartridges must not be reinstalled.

9.2.3 Cleaning the flow monitor



Figure 9-6 Unplugging the flow monitor

The flow monitor (9-6/1) must be removed and cleaned every six months.

To do this, remove the plug (9-6/2).



Figure 9-7 Unscrewing the flow monitor

Turn the flow monitor (9-7/1) **counterclockwise** using an AF22 mm open-end wrench



Figure 9-8 Cleaning the measuring probe

Clean the measuring probe (9-8/1) with a clean cloth.

Lightly grease the thread (not the probe).

After cleaning, reinstall the flow monitor in reverse order.

Reinsert the plug (9-6/2).

9. Care and maintenance

9.2.4 Cleaning the knife magazines



Figure 9-9 Cleaning the knife magazines

The knife magazines must be cleaned weekly with a steam jet outside the machine (see Figure 9-9).

9. Care and maintenance

9.3 Lubrication points

9.3.1 Lubricating the motors for the grinding belt drive

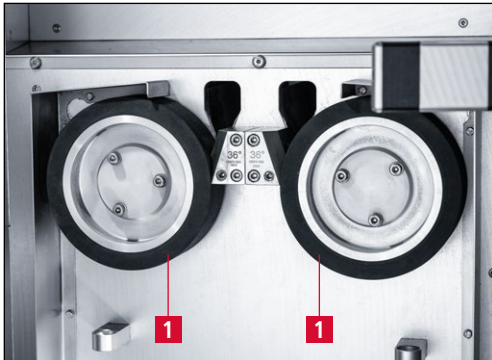

Figure 9-10 Removing the contact discs

To lubricate the grinding belt motors, remove the wet-grinding belts (see Chapter 7.2).

Remove both contact discs (9-10/1) using an AF 6 mm hexagon screwdriver.

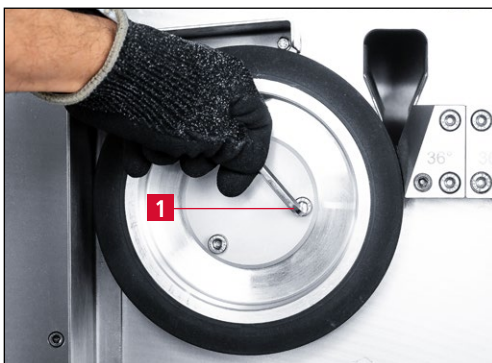

Figure 9-11 Removing the contact discs

Position the hexagon screwdriver so that it points to the centre of the contact disc (see Figure 9-11). This makes it much easier to loosen the screws.

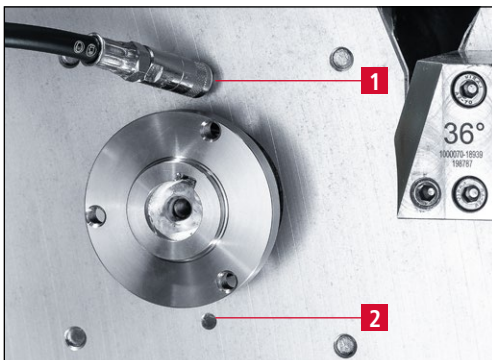

Figure 9-12 Lubricating the grinding belt motors

Using the hand lever grease press supplied, press grease into the lubrication nipple (9-12/1) until grease emerges from the hole (9-12/2) below the holding flange.

We recommend "Acinol 142S multi-purpose grease" or a corresponding commercial multi-purpose grease.

Lubricate both motors of the grinding belt drive.

9. Care and maintenance

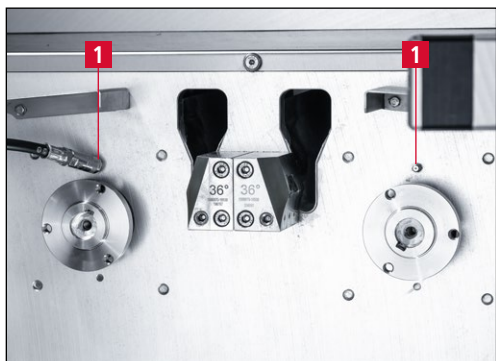

Figure 9-13 Lubrication nipples for grinding belt motors

There are two lubrication nipples (9-13/1) in total.

9.3.2 Lubricating the gripper



Figure 9-14 Moving an empty knife magazine into the machine

To lubricate the gripper, move an empty knife magazine (9-14/1) into the machine.



Figure 9-15 Control panel

Press the “Start/Stop” button (9-15/1) on the control panel.

9. Care and maintenance

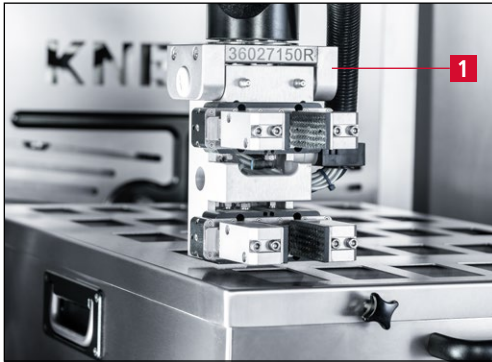

Figure 9-16 Gripper position

As soon as the gripper (9-16/1) is above the knife magazine, press the "Start/Stop" button (9-15/1) again to stop the machine.

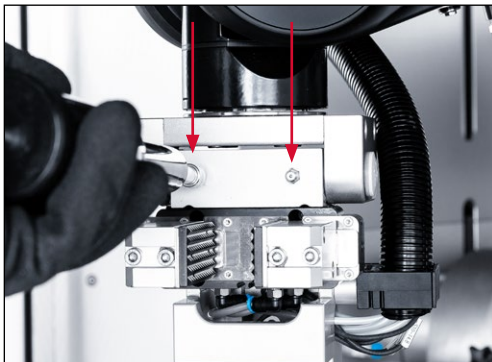

Figure 9-17 Lubricating the gripper on the front

Place the grease press on the two lubrication nipples at the front (9-17) and lubricate the gripper.

We recommend "OEST IXELON LT 000 EP" or a corresponding commercial fluid grease.

Once a month, use the grease press to pump two strokes of grease into the lubrication nipples.

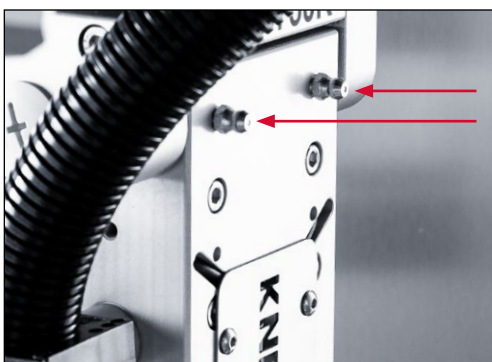

Figure 9-18 Lubricating the gripper on the rear

Place the grease press on the two lubrication nipples at the rear (9-18) and lubricate the gripper.

We recommend "OEST IXELON LT 000 EP" or a corresponding commercial fluid grease.

Once a month, use the grease press to pump two strokes of grease into the lubrication nipples.

There are four lubrication nipples on the gripper in total.

ATTENTION

Be sure to use the LT 000 EP fluid grease (tube) supplied or a corresponding commercial grease.

Regular machine grease will cause the gripper to stick.

9. Care and maintenance

9.3.3 Lubricating the sliding door

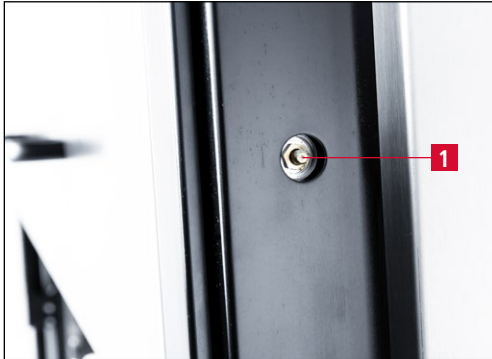

Figure 9-19 Lubricating the sliding door

To access the lubrication nipples (9-19/1) on the sliding door, move the door upwards until the lubrication nipples are visible in the openings of the frame (see Figure 9-19).

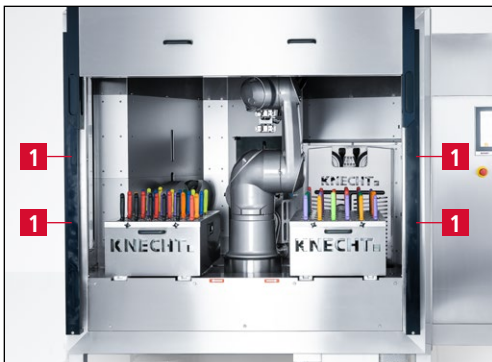

Figure 9-20 Lubrication nipples sliding door

Apply the grease press to the four lubrication nipples (9-20) and lubricate the sliding door.

We recommend "OEST IXELON LT 000 EP" or a corresponding commercial fluid grease.

Press two strokes of grease into the lubrication nipples with the grease press every month.

There are four lubrication nipples on the sliding door in total.

ATTENTION

Be sure to use the LT 000 EP fluid grease (tube) supplied or a corresponding commercial grease.

Regular machine grease will cause the sliding door to stick.

9. Care and maintenance

9.4 Maintenance plan (one-shift operation)

Interval	Assembly	Maintenance task
Daily	Polishing pastes	Check paste length. Exchange if less than 80 mm or if a corresponding message appears.
	Machine interior	Clean roughly with a brush or cloth.
	Coolant unit	Drain the water and clean the tray.
Weekly	Grinding-belt drive	Open the belt protection hood and clean the area around the grinding belt.
	Knife magazines	Clean the knife magazines (see Chapter 9.2.4).
	Suction unit	Empty the drawer of the suction unit (see Chapter 9.2.2).
		Check the filter cartridge, remove and clean or replace if necessary (see Chapter 9.2.2).
	Machine interior and exterior	Clean the machine inside and outside. Attention! Do not allow the deburring/polishing rings to get wet.
Monthly	Gripper	Clean the gripper surface with a wire brush. Unscrew the gripper jaws and clean the sealing surface.
Semi-annually	Grinding-belt drive	Remove and clean the flow monitor (see Chapter 9.2.3).
Annually		Contact the service department of KNECHT Maschinenbau GmbH

10. Disassembly and disposal

10.1 Disassembly

All operating materials must be disposed of properly.

Secure moving parts against slippage.

Disassembly must be conducted by a qualified specialist.

10.2 Disposal

After the machine has reached the end of its service life, it must be disposed of by a qualified specialist. In exceptional situations, and after consultation with KNECHT Maschinenbau GmbH, the machine may be returned.

Operating materials (e.g. wet-grinding belts, polishing/deburring rings, coolant etc.) must be disposed of correctly.

NOTE

The control unit's cooling device contains fluorinated greenhouse gases (F-gases, refrigerant R 513A, fill quantity 0.17 kg, CO² equivalent 0.11 t, GWP 631) in accordance with EU Regulation 2024/573.

The refrigerant must be removed properly before disassembly or disposal. Work may only be carried out by qualified personnel.

11. Service, spare parts and accessories

11.1 Postal address

KNECHT Maschinenbau GmbH
Witschwender Straße 26
88368 Bergatreute
Germany

Phone +49-7527-928-0
Fax +49-7527-928-32

mail@knecht.eu
www.knecht.eu

11.2 Service

Service line:

For address, see postal address

service@knecht.eu

11.3 Wear and spare parts

If you need spare parts, please use the spare parts list provided with the machine. Please place your order using the format described below.

When ordering, please always provide: (example)

Machine type	(E50R)
Machine number	(001025720)
Designation of assembly	(Gear housing_2PO)
Designation of single part	(Output shaft_bottom)
Item number (position number)	(19)
Drawing number (article number)	(2000135-11969)
Quantity	(1 pc)

We are always happy to answer any questions.

11. Service, spare parts and accessories

11.4 Accessories

11.4.1 Abrasives used and others

Type	Dimensions	Grain	Article number	Notes
Wet-grinding belt	2200x60	K240	412A-66-0728	installed on delivery
Deburring ring (left)	d.180x6xd.32		412N-03-0180	installed on delivery
Polishing ring (right)	d.180x6xd.32		412N-05-0180	installed on delivery
Polishing paste	230x60x50		412R-01-0501	installed on delivery
Fluid grease IXELON LT000 EP	900 g		417B-02-0100	included in scope of delivery

ATTENTION

Only original abrasives, wear and spare parts from KNECHT Maschinenbau GmbH are permitted to be used.

KNECHT Maschinenbau GmbH assumes no responsibility for the use of non-original parts.

If you require abrasives or other accessories, please contact our sales staff and distributors, or KNECHT Maschinenbau GmbH directly.

Thank you for choosing KNECHT!

12. Appendix

12.1 EU Declaration of Conformity

in accordance with EU Directive 2006/42/EU

- Machinery 2006/42/EU
- Electromagnetic Compatibility 2014/30/EU

We hereby declare that the machine designated as follows, due to its construction and design, as well as the version we introduced on the market, complies with the relevant basic safety and health requirements of the applicable EU Directive.

In case of a modification of the machine not agreed with us, this declaration loses its validity.

Designation of machine:	Fully Automatic Hand Knife Sharpening Machine
Model designation:	E 50 R
Machine number:	from no. 01126650R
Applicable harmonized standards, in particular:	DIN EN ISO 12100 DIN EN ISO 13849-1 DIN EN ISO 13857 DIN EN ISO 16089 DIN EN 61000-3-2 DIN EN 61000-3-3 DIN EN 55014-1 DIN EN 13854
Responsible for documentation:	Andreas Doerr (State-certified technician) Phone +49-7527-928-81 a.doerr@knecht.eu
Manufacturer:	KNECHT Maschinenbau GmbH Witschwender Straße 26 88368 Bergatreute Germany

A complete technical documentation is available. The operating instructions document for the machine is available in its original version and in the native language of the user.

The validity of the declaration expires in the event of changes to the legal requirements.

Bergatreute, March 26, 2026

KNECHT Maschinenbau GmbH



Markus Knecht
CEO

