

Operating Instructions

A 95

Grinding Machine for Sickle-shaped and Circular Knives



Operating Instructions

A 95 Grinding Machine for Sickle-shaped and Circular Knives

Manufacturer

KNECHT Maschinenbau GmbH
Witschwender Straße 26
88368 Bergatreute
Germany

Phone +49-7527-928-0
Fax +49-7527-928-32

mail@knecht.eu
www.knecht.eu

Documents for machine operator

Operating Instructions

Date of issue of the operating instructions

November 16, 2023

Copyright

These operating instructions as well as the operating documents remain the copyright property of KNECHT Maschinenbau GmbH. They are supplied only to customers and operators of our products and belong to the machine.

Without our express permission, these documents may neither be duplicated nor made accessible to third parties, in particular competitor companies.

Table of Contents

1.	Important notes	8
1.1	Preface to the operating instructions	8
1.2	Warnings and symbols in the operating instructions	8
1.3	Warning and mandatory signs and their meaning	9
1.3.1	Warning and mandatory signs on/in the grinding machine	9
1.4	Rating plate and machine serial number	10
1.5	Figure and position numbers in the operating instructions	10
2.	Safety	11
2.1	Basic safety instructions	11
2.1.1	Observe notes in the operating instructions	11
2.1.2	Obligation on the part of the operator	11
2.1.3	Obligation on the part of the personnel	11
2.1.4	Hazards involved in handling the grinding machine	11
2.1.5	Malfunctions	12
2.2	Intended use	12
2.3	Warranty and liability	12
2.4	Safety regulations	13
2.4.1	Organizational measures	13
2.4.2	Protective equipment	13
2.4.3	Informal safety measures	13
2.4.4	Selection and qualification of personnel	13
2.4.5	Machine control system	14
2.4.6	Safety measures in normal operation	14
2.4.7	Hazards due to electrical power sources	14
2.4.8	Particular hazard areas	15
2.4.9	Servicing (maintenance, repair) and fault rectification	15
2.4.10	Structural alterations to the grinding machine	15
2.4.11	Cleaning the grinding machine	15
2.4.12	Lubricants/oils and greases	15
2.4.13	Relocation of the grinding machine	15
3.	Description	17
3.1	Intended use	17
3.2	Technical specifications	17
3.3	Functional description	18
3.4	Description of assemblies	19
3.4.1	Grinding unit	20
3.4.2	Axes	20
3.4.3	Laser measuring unit and serration unit (optional)	21
3.4.4	Coolant pump	21
3.4.5	Flow monitor	21
3.4.6	Pneumatics	22
3.4.7	Switching the grinding machine on/off	22

Table of Contents

3.4.8	Control panel	23
3.4.9	Structure of the user interface (main screen)	24
4.	Transport	26
4.1	Transport aids	26
4.2	Transport damage	26
4.3	Transport to another installation site	26
5.	Installation	27
5.1	Selection of qualified personnel	27
5.2	Installation site	27
5.3	Supply connections	27
5.4	Settings	27
5.5	Initial start-up of the grinding machine	28
6.	Commissioning	29
7.	Operation	31
7.1	Switch on the grinding machine	31
7.2	Grinding sickle-shaped knives	31
7.2.1	Loading the grinding program	31
7.2.2	Clamping the sickle-shaped knife	33
7.2.3	Grinding the sickle-shaped knife	37
7.2.4	Polishing the sickle-shaped knife (optional)	37
7.3	Serrating / re-serrating sickle-shaped knives	38
7.3.1	Loading the grinding program	38
7.3.2	Measuring the profiling wheel	39
7.3.3	Clamping the sickle-shaped knife	40
7.3.4	Serrating/re-serrating the sickle-shaped knife	44
7.3.5	Polishing the serrated sickle-shaped knife	44
7.4	Grinding circular knives	45
7.4.1	Loading the grinding program	45
7.4.2	Clamping the circular knife	46
7.4.3	Grinding the circular knife	49
7.4.4	Polishing the circular knife (optional)	50
7.5	Serrating / re-serrating circular knives	51
7.5.1	Loading the grinding program	51
7.5.2	Measuring the profiling wheel	52
7.5.3	Clamping the circular knife	53
7.5.4	Serrating/re-serrating the circular knife	56
7.5.5	Polishing the serrated circular knife	57

Table of Contents

7.6	Positioning the polishing unit (optional)	58
7.7	Changing the front/rear grinding wheels	59
7.7.1	Intermediate flange for ceramic grinding wheels	60
7.8	Changing the profiling wheel (optional)	61
7.9	Dressing ceramic grinding wheels front/rear	63
8.	Control	65
<hr/>		
8.1	Settings	65
8.2	Serrating (re-serrating)	66
8.3	Axes manual operation	69
8.4	Grinding data	71
8.4.1	Data	72
8.4.2	Data – Contour	72
8.4.3	Data – Serration	73
8.4.4	Data – Change position	74
8.4.5	Data – Abrasives	74
8.4.6	Steps – Step 1	74
8.4.7	Feeds – Feed 1 – Steps – Step 1	75
8.5	Manual functions	76
8.5.1	General	76
8.5.2	Grinding wheel front	77
8.5.3	Grinding wheel rear	77
8.5.4	Serration unit	78
8.5.5	Polishing unit	78
8.6	Message texts	79
8.7	Options	79
8.8	Knife contour	80
8.8.1	Axial run-out	81
8.8.2	Contour deviation	81
8.9	Knife selection	82
8.10	Setting up an internet connection	83
9.	Care and maintenance	84
<hr/>		
9.1	Coolant	84
9.1.1	Coolant additive	84
9.2	Cleaning	84
9.2.1	Cleaning agent and lubricant table	85
9.3	Maintenance plan (one-shift operation)	85
9.4	Lubrication points	86
9.4.1	Lubricating the grinding wheel slide	86
9.4.2	Lubricating the angle adjustment slide	86
9.4.3	Lubricating the serration unit (optional)	87
9.4.4	Lubricating the polishing unit (optional)	87
9.4.5	Lubricating the cross slide	88

Table of Contents

10.	Disassembly and disposal	90
10.1	Disassembly	90
10.2	Disposal	90
11.	Service, spare parts and accessories	91
11.1	Postal address	91
11.2	Service	91
11.3	Wear and spare parts	91
11.4	Accessories	92
11.4.1	Abrasives used etc.	92
11.4.2	Abrasives used etc. for serration unit and polishing unit	92
12.	Appendix	94
12.1	EU Declaration of Conformity	94

1. Important notes

1.1 Preface to the operating instructions

These operating instructions are intended to make it easy to learn how to use the grinding machine for sickle-shaped and circular knives, hereafter referred to as the grinding machine, and to properly utilize its features.

These operating instructions contain important notes on how to operate the grinding machine safely, properly and efficiently. Observing these instructions helps to avoid hazards, reduce repair costs and downtimes, and to increase the reliability and service life of the grinding machine.

The operating instructions must always be stored in the location that the grinding machine is used.

The operating instructions must be read and applied by every person tasked with working with the grinding machine, e.g.:

- transport, installation, commissioning
- operation, including error rectification during operation, as well as
- servicing (maintenance, repair).

Recognized technical standards for safe and professional work must be observed in addition to these operating instructions and the binding accident prevention regulations applicable in the country of use and at the place of use.

1.2 Warnings and symbols in the operating instructions

The operating instructions use the following symbols/designations that must be followed:



The hazard triangle with the signal word "CAUTION" serves as a work safety notice for all work for which there is a risk of personal injury or death.

In these cases, work should be done with special attention and care.



"ATTENTION" is written in places where special attention must be paid to prevent damage or destruction of the grinding machine or its surroundings.



"NOTICE" refers to user tips and especially useful informations.

1. Important notes

1.3 Warning and mandatory signs and their meaning

1.3.1 Warning and mandatory signs on/in the grinding machine

The following warnings and mandatory signs have been affixed on/in the grinding machine:



CAUTION! DANGEROUS ELECTRICAL VOLTAGE!
(warning sign on the control cabinet)

The grinding machine carries life-threatening voltage when it is connected to the power supply.

Voltage-carrying device parts may only be opened by authorized personnel.

The grinding machine must be separated from the mains supply before carrying out servicing, maintenance and repair work on it.



CAUTION! RISK OF INJURY DUE TO ABRASIVE PARTICLES!
(mandatory sign on the slide of the Z-axis)

Dressing the grinding wheel gives rise to abrasive particles that can get into the eyes.

Wearing eye protection is mandatory when carrying out such work.



CAUTION! RISK OF INJURY FROM KNIFE!
(mandatory sign on the slide of the Z-axis)

Working with the grinding machine involves grinding knives that could cause serious cut injuries due to their sharpness.

Protective gloves must be worn when clamping and releasing knives.

Caution when transporting knives. Use the protective equipment provided by the knife manufacturer. Protective gloves and safety shoes must be worn.

1. Important notes

1.4 Rating plate and machine serial number



Figure 1-1 Rating plate

The rating plate (1-1) is located on the left side of the machine.



Figure 1-2 Machine serial number

The machine serial number (1-2) is located on the rating plate (1-1) and at the front left at the machine.

1.5 Figure and position numbers in the operating instructions

If the text refers to a component of the machine that is shown in a figure, the figure and position number is given in brackets.

Example: (6-1/1) means picture number 6-1, position 1.

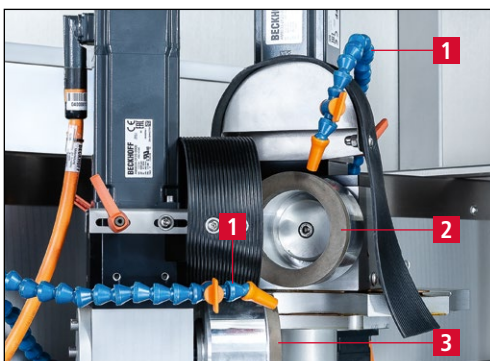

Figure 6-1 Adjusting the coolant hose

Open safety doors.

Adjust the coolant hose (6-1/1) as shown in the figure. The distance to the rear grinding wheel (6-1/2) and front grinding wheel (6-1/3) should be approx. 5 mm. The coolant hose must not touch the grinding wheels.

2. Safety

2.1 Basic safety instructions

2.1.1 Observe notes in the operating instructions

The basic prerequisite for the safe handling and uninterrupted operation of this grinding machine is knowledge of the basic safety instructions and regulations.

- These operating instructions contain important notes on how to operate the grinding machine safely.
- All persons carrying out work on the grinding machine must follow these operating instructions, in particular the safety notices.
- In addition, the rules and regulations regarding accident prevention at the place of use are to be observed.

2.1.2 Obligation on the part of the operator

The operator is obliged to allow only those persons to work on the grinding machine, who

- are familiar with the occupational safety and accident prevention regulations and have received instruction in handling the grinding machine,
- have read and understood the operating instructions, in particular the section entitled "Safety" and the warning notes, and have provided signed confirmation of this.

The safety-awareness of the personnel at work will be monitored at regular intervals.

2.1.3 Obligation on the part of the personnel

All personnel working on the grinding machine shall be obliged, before starting work, to

- observe basic occupational safety and accident prevention regulations,
- read the operating instructions, particularly the section entitled "Safety" and the warning notes, and provide signed confirmation that they have understood them.

2.1.4 Hazards involved in handling the grinding machine

The grinding machine has been built to the latest technological standards and the recognized rules of technical safety. In spite of this, its use poses inherent risks which could result in bodily harm or even death of the user or third persons, or damage to the grinding machine or other property.

The grinding machine may be used only:

- for its intended purpose
- in a safe and secure condition.

2. Safety

Malfunctions that may impair safety are to be eliminated immediately.

2.1.5 Malfunctions

If safety-relevant malfunctions occur with the grinding machine, or if the processing behavior indicates that such malfunctions may have occurred, the grinding machine must be stopped immediately and until such time as the malfunction has been found and eliminated.

Allow only authorized trained personnel to eliminate the malfunctions.

2.2 Intended use

The grinding machine is intended exclusively for grinding and serrating circular and sickle-shaped knives. Before working on a knife, it must first be checked whether the knife fits on the knife mounting plate. Only then may the knife be clamped onto the knife mounting plate.

Any other use or use beyond this is not considered as intended. KNECHT Maschinenbau GmbH is not liable for any damage resulting from this. The risk is borne solely by the user.

Intended use also includes observing all instructions in the operating manual.

ATTENTION

Improper use of the grinding machine exists, for example, if:

- **knives are ground without a knife mounting plate.**
- **fixtures are not properly attached.**

2.3 Warranty and liability

Warranty and liability claims in case of personal injury or property damage are excluded if such damage is attributable to one or more of the following causes:

- improper use of the grinding machine,
- improper transport, commissioning, operation, and maintenance of the grinding machine,
- operating the grinding machine with defective safety devices, or using improperly attached or malfunctioning safety and protective equipment,
- failure to observe the instructions with regard to transportation, commissioning, operation, maintenance and repair of the grinding machine,
- unauthorized structural alterations to the grinding machine,

2. Safety

- unauthorized modification, e.g. of the drive conditions (output and speed),
- failure to monitor machine parts that are subject to wear, and
- use of unapproved replacement and wear parts.

Use only original replacement and wear parts. If externally purchased parts are used, it is not guaranteed that they have been designed and manufactured to meet the requirements in terms of stress and safety.

2.4 Safety regulations

2.4.1 Organizational measures

Inspect all available safety devices regularly.

Observe prescribed intervals for recurring maintenance work or as specified in the operating instructions!

2.4.2 Protective equipment

Before every commissioning of the grinding machine, ensure that all protective equipment is properly mounted and in functional condition.

Protective equipment may be removed only after the grinding machine has stopped and has been secured against accidental restart.

When attaching spare parts, the protective equipment must be attached by the operator as stipulated.

2.4.3 Informal safety measures

The operating instructions must be permanently available at the place of use of the grinding machine. In addition to the operating instructions, the generally applicable as well as locally relevant accident prevention regulations must also be made available and observed.

All safety alert symbols and hazard warnings on the grinding machine must be complete and clearly legible.

2.4.4 Selection and qualification of personnel

Only trained and instructed personnel may work on the grinding machine. Observe the legally permitted minimum age!

The responsibilities of personnel with respect to commissioning, operation, maintenance, and repair must be clearly specified.

2. Safety

Personnel still undergoing training or instruction may only work on the grinding machine under the permanent supervision of an experienced person!

2.4.5 Machine control system

Under no circumstances make program changes to the software. Parameters that the operator can set himself are excluded from this (e.g. setting the number of cycles).

Only trained and instructed personnel are permitted to switch on and operate the machine.

2.4.6 Safety measures in normal operation

Do not operate the machine in any unsafe manner. Only operate the grinding machine if all the safety devices are installed and fully functional.

At least once per shift (or per day), check the grinding machine for externally visible damage and proper functioning of the safety devices.

Immediately report any changes present (including those of the operating behavior) to the responsible office or person. If necessary, immediately shut down the grinding machine and secure it against restart.

Before you switch on the grinding machine, ensure that no one can be injured by the start-up of the machine.

In the event of a malfunction, immediately stop the grinding machine and secure it against restart. Rectify malfunctions immediately.

2.4.7 Hazards due to electrical power sources

The control cabinet must always be kept closed. Access is only permitted to authorized personnel.

Work on electrical systems or operating materials may only be performed by a qualified electrician, in accordance with electrical regulations.

Defects, such as damaged cables, cable connections, etc. must be immediately rectified by an authorized specialist.



The yellow power supply cable is electrically live even when the main switch is turned off.

2. Safety

2.4.8 Particular hazard areas

In the area of the grinding wheels, profiling wheel and polishing brushes, there is a risk of crushing and of e.g. clothing, fingers and hair being drawn in. Suitable personal protective equipment must be worn.

2.4.9 Servicing (maintenance, repair) and fault rectification

Maintenance work is to be carried out on schedule by trained personnel. Inform operating personnel before beginning repair work. Designate a supervisor responsible for this.

For all service work, the grinding machine is to be disconnected from the current supply and secured against accidental restart. Remove power plug. Secure repair area as necessary.

After completing maintenance work and rectifying any faults, install all safety devices and verify that they are fully functional.

2.4.10 Structural alterations to the grinding machine

Do not make any changes, additions or conversions to the grinding machine without the approval of the manufacturer. This also applies to the installation and setup of safety devices.

Any conversion work requires the written permission from KNECHT Maschinenbau GmbH.

Immediately replace machine parts that are not in perfect condition.

Use only original replacement and wear parts. If externally purchased parts are used, it is not guaranteed that they have been designed and manufactured to meet the requirements in terms of stress and safety.

2.4.11 Cleaning the grinding machine

Properly handle any cleaning agents and materials used and dispose of them in an environmentally-friendly manner.

Dispose of the wear parts and replacement parts in a safe and environmentally-friendly manner.

2.4.12 Lubricants / oils and greases

When using oils and greases, follow the safety regulations applicable to the product. Comply with the special regulations for the food areas

2.4.13 Relocation of the grinding machine

Disconnect the grinding machine from any external power supply, even in the event of a minor change of location. Before restarting the grinding machine, connect it properly to the power supply.

2. Safety

For loading work, use only lifting equipment and load-bearing devices with sufficient lifting capacity. Appoint a qualified instructor for the lifting operation.

No persons other than those designated for this work may be present in the loading and installation area.

Only lift the grinding machine properly with lifting gear as specified in the operating instructions. Only use a suitable transport vehicle with sufficient load-bearing capacity. Secure the load reliably. Use suitable attachment points.

When restarting the machine, proceed only in accordance with the operating instructions.

3. Description

3.1 Intended use

The A95 Grinding Machine for Sickle-shaped and Circular Knives automatically grinds sickle-shaped knives, circular knives or similar cutting tools (hereinafter referred to as knives) up to a radius of 600 mm.

Optionally, the knives can be measured for axial runout, serrated and the cutting edge be polished.

3.2 Technical specifications

Height	_____	approx. 2280 mm
Width	_____	approx. 2255 mm
Depth	_____	approx. 1270 mm
Space requirement (WxDxH)	_____	3500x2100x2300 mm
Weight	_____	approx. 800 kg
Power supply*	_____	3x 400 V
Mains frequency*	_____	50/60 Hz
Power output*	_____	9 kW
Power consumption*	_____	11 kW
Current consumption*	_____	14 A
Back-up fuse*	_____	32 A
Control voltage*	_____	24 V DC
Compressed air supply according ISO 8573-1:2010 [1:4:2]	_____	6.5 bar (50 l/min)
Measured A-weighted emission sound pressure level at the workplace LpA**	_____	72 dB (A)
Grinding wheel speed front/rear	_____	0-1000 1/min
Grinding wheel front/rear	_____	d.100x60xd.40
Speed profiling wheel (optional)	_____	2600 1/min
Profiling wheel (optional)	_____	d.200x5xd.17

*) This information may change depending on the electrical power supply.

**) Two-digit sound emission value according to EN ISO 4871 (measurement uncertainty KpA. 3 dB (A)). Emission sound pressure level according to EN ISO 11201. A sickle-shaped knife (type known from the company KNECHT Maschinenbau GmbH) was ground.

3. Description

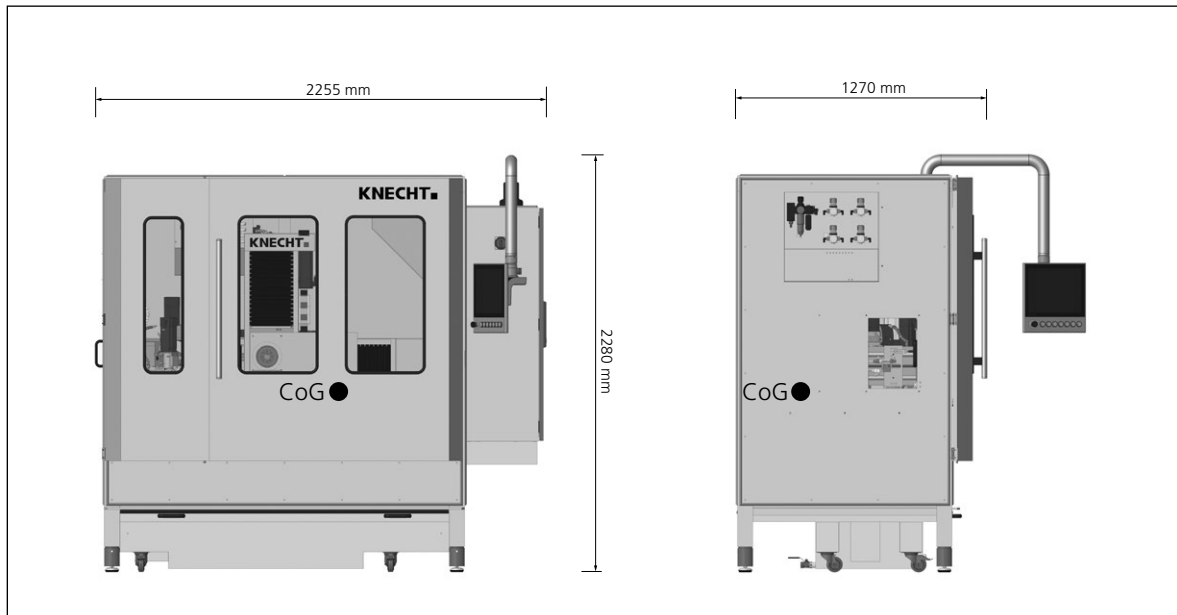

Figure 3-1 Dimensions in mm and centers of gravity (CoG) of the machine

3.3 Functional description

With the A95 Grinding Machine for Sickle-shaped and Circular Knives, sickle-shaped and circular cutting tools up to a radius of 600 mm can be ground and deburred automatically.

The knife is mounted on an individual knife mounting plate and machined fully automatically after program start.

Optionally, these cutting tools can be initial-serrated and re-serrated on the A95. For this purpose, the flatness of the knife is measured by a 2-D laser before serrating. During serrating, the grinding machine compensates for the axial runout of the knife. As a result, uniform serration is obtained over the entire outer contour of the cutting tool.

The serration is finally polished to a burr-free finish with a polishing unit.

With the "emergency stop" function, the grinding machine can be brought to an immediate complete stop at any time.

3. Description

3.4 Description of assemblies

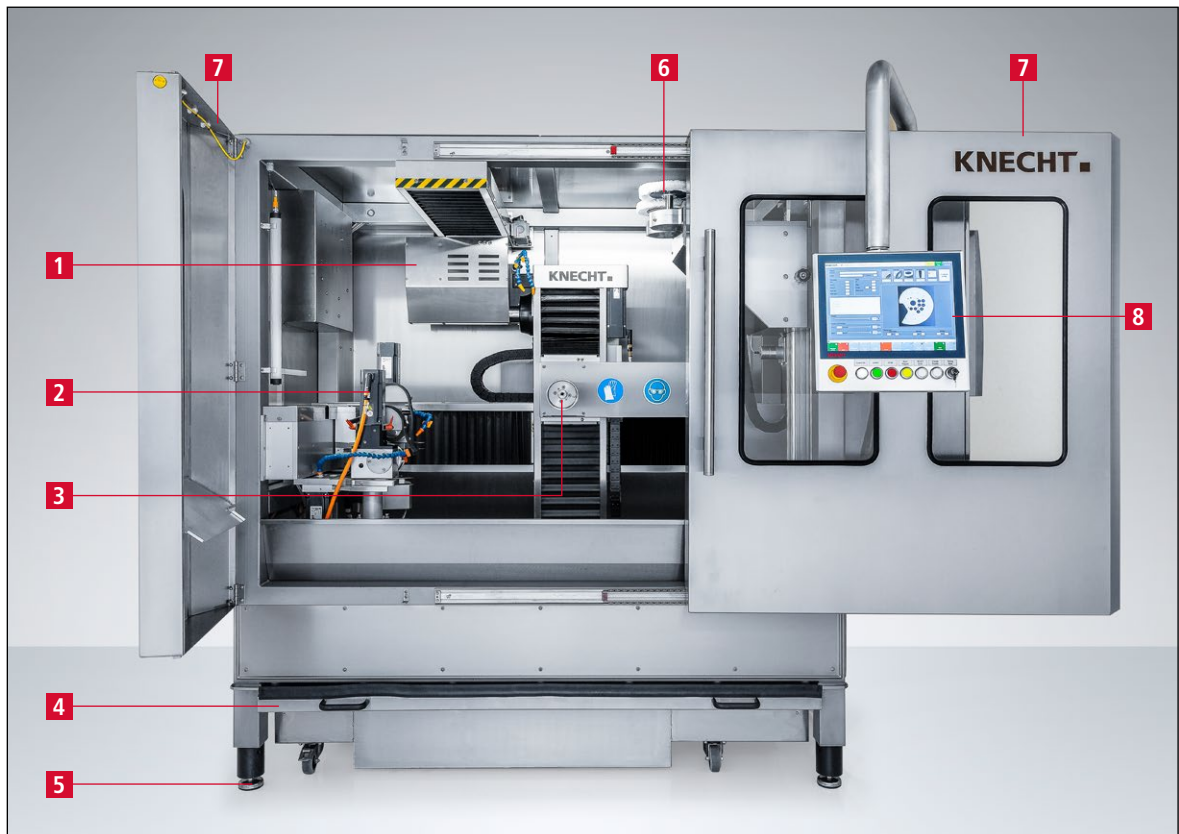
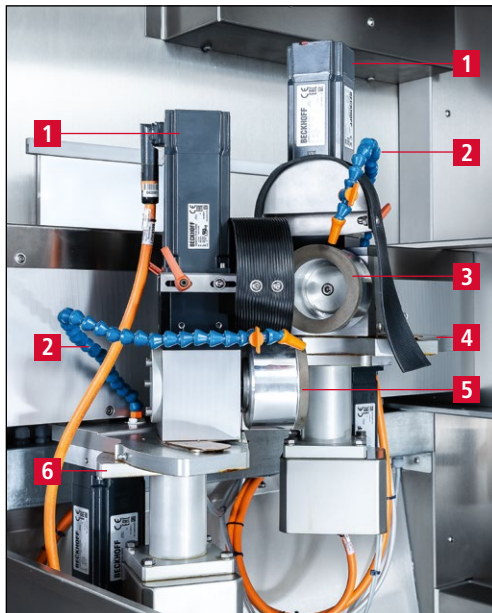

Figure 3-2 General view of grinding machine

- 1 Serration unit and laser measuring unit (optional)
- 2 Front and rear grinding unit
- 3 Holding flange
- 4 Water tray
- 5 Adjustable machine feet
- 6 Polishing unit (optional)
- 7 Safety door
- 8 Control panel

3. Description

3.4.1 Grinding unit



- 1 Servomotor for grinding wheels
- 2 Coolant hose
- 3 Grinding wheel rear
- 4 Grinding angle display at rear (hidden)
- 5 Grinding wheel front
- 6 Grinding angle display front

Figure 3-3 Grinding unit

3.4.2 Axes

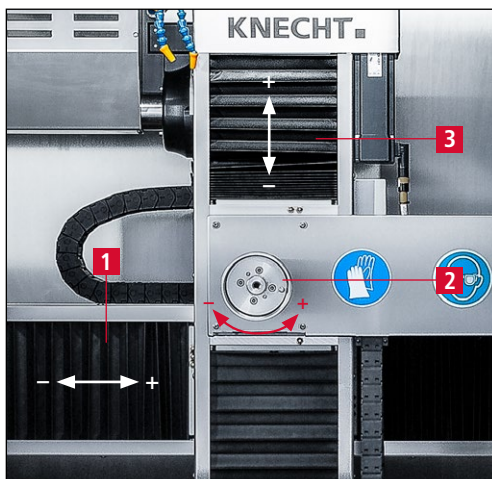

- 1 X-axis
- 2 B-axis
- 3 Z-axis

Figure 3-4 Axes

3. Description

3.4.3 Laser measuring unit and serration unit (optional)

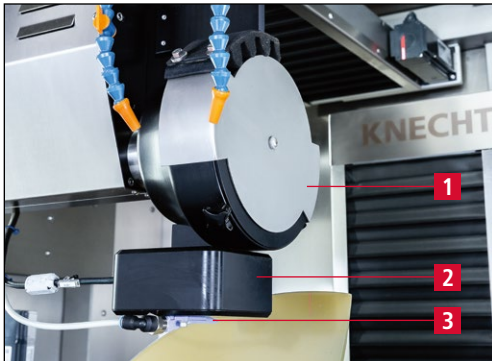

Figure 3-5 Laser measuring unit and serration unit

- 1 Serration unit
- 2 Laser scanner with blow-off device
- 3 Blow-off nozzle

3.4.4 Coolant pump

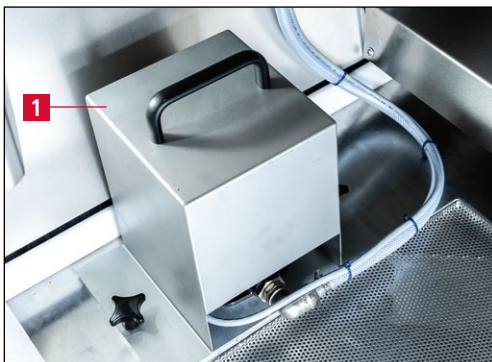

Figure 3-6 Coolant pump

- 1 Coolant pump with cover

3.4.5 Flow monitor

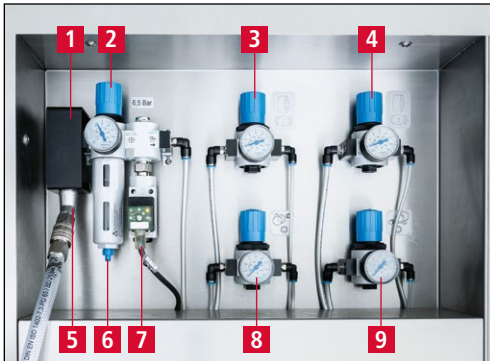

Figure 3-7 Flow monitor

- 1 Flow monitor

3. Description

3.4.6 Pneumatics



- 1 Connection block
- 2 Setting pressure monitoring
- 3 Angle clamping rear
- 4 Angle clamping front
- 5 Compressed air connection (6.5 bar)
- 6 Water separator (6 bar)
- 7 Pressure monitoring
- 8 Pressure reducer grinding wheel rear (4 bar)
- 9 Pressure reducer grinding wheel front (4 bar)

Figure 3-8 Pneumatics

3.4.7 Switching the grinding machine on/off



- 1 Main switch
- 2 Cooling system

Turning the main switch to position "1 ON" the grinding machine is switched ready for operation.

Turning the main switch to position "0 OFF" the grinding machine is switched off.

Figure 3-9 Control cabinet

3. Description

3.4.8 Control panel



Figure 3-10 Control panel

- 1 Screen
- 2 "Emergency stop" button
- 3 "Control ON" button: activate control (when button flashes)
- 4 "START" button: start grinding program
- 5 "STOP" button: stop grinding program (after restart, the machine continues the grinding program at the point where it was interrupted)
- 6 "Program abort" button: abort current grinding program
- 7 "RESET Error" button: reset machine control (knife type must afterwards be reloaded)
- 8 "Change position" button: move machine to change position
- 9 "Setup mode" key switch: position "1" for setup mode, position "0" for automatic mode.

3. Description

3.4.9 Structure of the user interface (main screen)

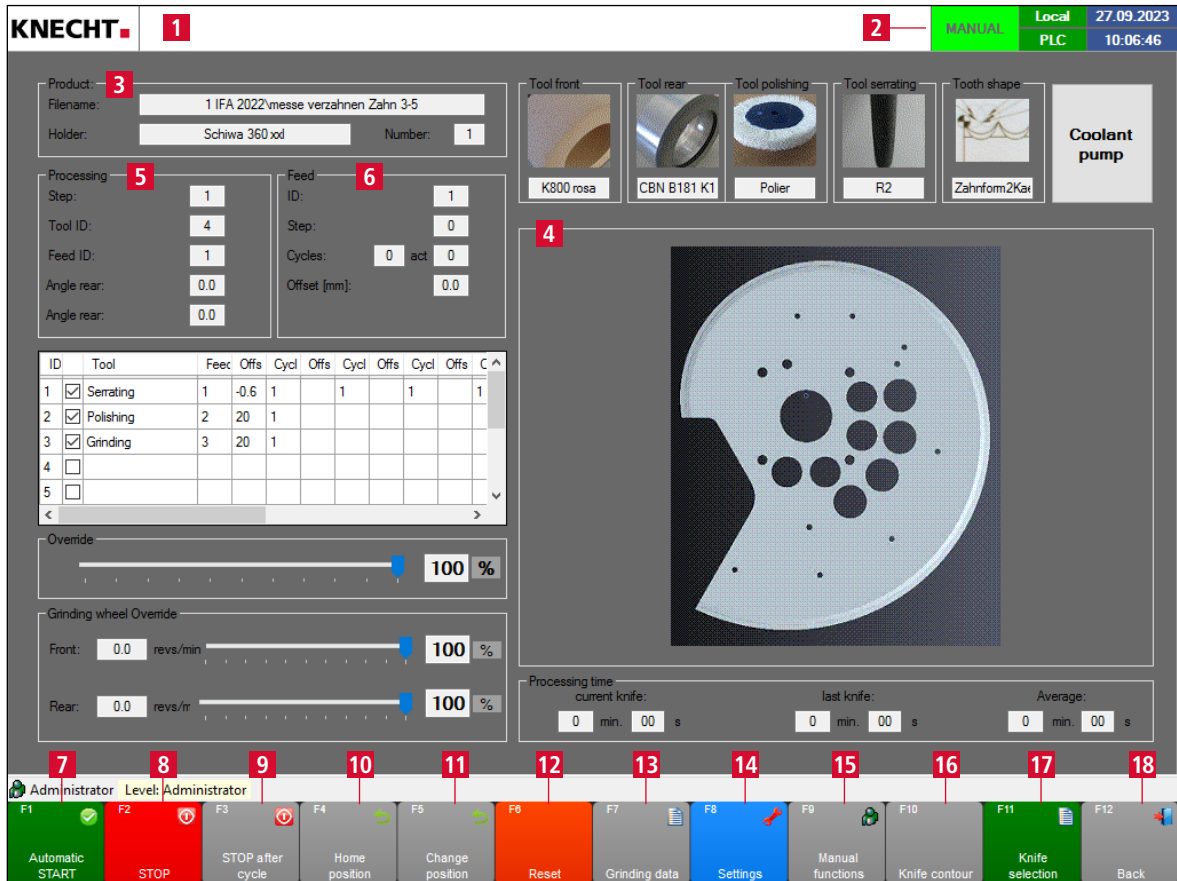

Figure 3-11 Main screen

- 1 Error messages
- 2 Status display
- 3 Product data (loaded grinding program and associated geometry file)
- 4 Stored figures (display of current knife, tools used and tooth shape)
- 5 Current settings for machining steps (stored in the grinding program)
- 6 Current infeed settings (stored in the grinding program)
- 7 **“Automatic START”**: start grinding program, corresponds to “START” button (3-10/4)
- 8 **“STOP”**: stop grinding program, corresponds to “STOP” button (3-10/5)
- 9 **“STOP after cycle”**
- 10 **“Home position”**: knife mounting plate moves to the basic position specified in the machine data (machine-dependent)
- 11 **“Change position”**: knife mounting plate moves to the knife change position specified in the knife data (knife-dependent)
- 12 **“Reset”**: reset all data of the machine control (state after switching on the machine is restored)
- 13 **“Grinding data”**: see Chapter 8.4
- 14 **“Settings”**: see Chapter 8.1
- 15 **“Manual functions”**: see Chapter 8.5

3. Description

- 16 **"Knife contour"**: display loaded knife contour
- 17 **"Knife selection"**: select the knife to be processed
- 18 **"Back"**: switch to the previous display

NOTE

The assignment of the touch panel fields changes depending on the current display. The respective assignment is indicated by text.

4. Transport



When transporting, observe the local applicable safety and accident prevention regulations.

Only transport the grinding machine with the machine feet facing downwards.

4.1 Transport aids

For transporting and for setting up of the grinding machine, only use adequately dimensioned transport aids. Pull out the water tray (3-2/4) before transport.

When using a forklift or a lifting truck, move the fork under the grinding machine.

Note the machine's center of gravity when transporting. The center of gravity (CoG) is shown in Figure 3-1.

4.2 Transport damage

If damage is detected after unloading, during acceptance of the delivery, immediately inform KNECHT Maschinenbau GmbH and the forwarding agent. If necessary, an independent expert must be called in immediately.

Remove packaging and fastening straps. Dispose of packaging in an environmentally friendly manner.

4.3 Transport to another installation site

For transport to another installation site, ensure that the space requirements are fulfilled (see Chapter 3.2).

A permitted electrical connection, pneumatic connection and network connection must be available at the new installation site. The grinding machine must stand firmly and securely.



Work on the electrical unit is only to be carried out by an authorized specialist. Observe the locally applicable safety and accident prevention regulations.

5. Installation

5.1 Selection of qualified personnel



We recommend having installation work on the grinding machine carried out by the trained KNECHT personnel.

We are not liable for any damage resulting from improper installation.

5.2 Installation site

When determining the installation site, bear in mind the space required for installation as well as maintenance and repair work on the grinding machine (see Chapter 3.2).

The machine may only be stored and operated in dry rooms.

5.3 Supply connections

The grinding machine is provided ready to connect with the corresponding connection cable.

The power supply must be installed on site by a qualified electrician.

The compressed air supply and the network connection must be installed on site by a qualified technician.



Only connect compressed air when the doors are closed.

Never remove compressed air when the knife is clamped. Serious injuries are possible.

Check that the power supply is connected correctly.

5.4 Settings

KNECHT Maschinenbau GmbH will configure the various components as well as the electrical system before delivery.

ATTENTION

Unauthorized alterations to the preset values are not permitted and can damage the grinding machine.

5. Installation

5.5 Initial start-up of the grinding machine

Place the grinding machine at the installation site on a level base.

Compensate uneven floors by turning the machine feet (3-2/5) with an AF 19 mm open-end wrench. Align the machine using a spirit level. To do this, place the spirit level on the guide rails of the grinding machine.

Dismantle all transport devices on the machine. Ensure that all axes (Figure 3-4) can move freely.

Have the power supply installed on site by a qualified electrician.

Have the compressed air supply and the network connection installed on site by a qualified technician.

Completely install and inspect the protective equipment before commissioning.



Have all protective equipment checked for proper functioning by authorized trained personnel before commissioning the machine.

6. Commissioning



All work may only be carried out by authorized specialist personnel.

The applicable local safety and accident prevention regulations must be observed.

Connect compressed air only when the doors are closed.

Never remove compressed air when the knife is clamped. Serious injuries are possible.

Fill the water tray (3-2/4) with water up to 5 cm below the edge.

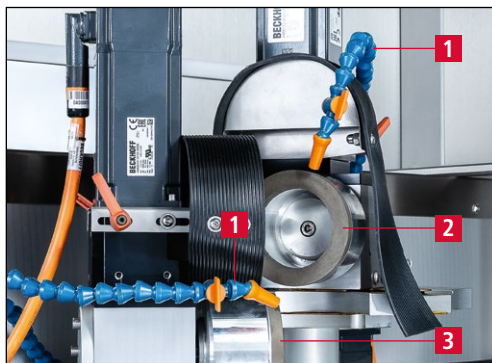

Figure 6-1 Adjusting the coolant hose

Open the safety doors.

Adjust the coolant hose (6-1/1) as shown in the figure. The distance to the rear grinding wheel (6-1/2) and grinding wheel in front (6-1/3) should be approx. 5 mm. The coolant hose may not touch the grinding wheels.

ATTENTION

Maintain a minimum distance of 5 mm between the coolant hose and the grinding wheels, since the grinding wheels rotate during the grinding process.

Connect the power plug to the socket provided on site (3x 400 V, 32 A).

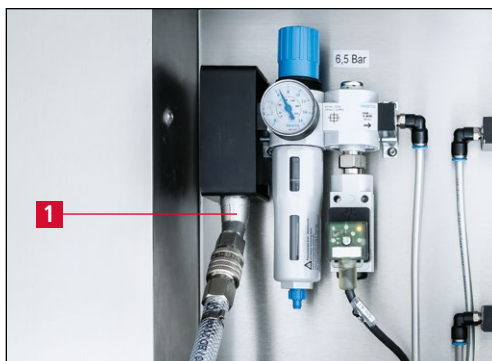

Figure 6-2 Compressed air connection

Connect the compressed air hose to the compressed air connection (6-2/1).

Close the safety doors.

6. Commissioning



Figure 6-3 Control panel

Set the main switch (3-9/1) to the "1 ON" position. Wait for the control unit to initialize.

When the "Control ON" button (6-3/1) flashes, switch on the control unit with the "Control ON" button (6-3/1).

ATTENTION

Do not press the "START" button (6-3/2) under any circumstances.

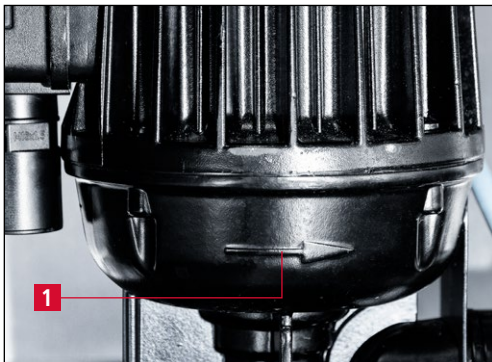

Figure 6-4 Check rotating direction

Check rotating direction of coolant pump.

The direction arrow (6-4/1) indicates the rotating direction of the pump.

If the rotating direction is incorrect, have the phase reversed by a qualified electrician.

7. Operation



All work may only be carried out by authorized specialist personnel.

The applicable local safety and accident prevention regulations must be observed.

Never clamp the knife without knife protector. Serious injuries are possible.

7.1 Switch on the grinding machine

Set the main switch (3-9/1) to "1 ON". Wait for the control unit to initialize. The main screen appears on the control panel (3-10).

When the control is ready, the "Control ON" button (3-10/3) flashes.

Press the "Control ON" button (3-10/3) to activate the control. If this is possible the "Control ON" button lights up permanently.

Turn the key switch (3-10/9) to position "0" (automatic mode).

7.2 Grinding sickle-shaped knives

7.2.1 Loading the grinding program

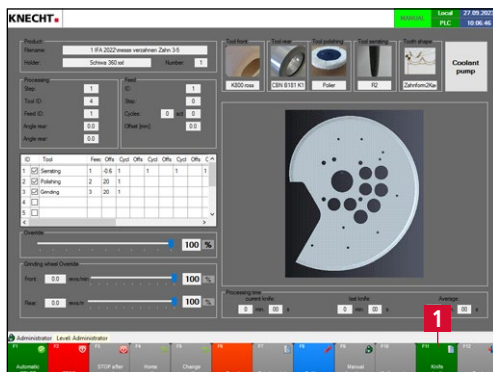

Figure 7-1 Main screen

On the main screen, press the touch panel field "Knife selection" (7-1/1). The dialog box "Open" appears.

You will find the grinding programs in the "Product data" folder.

7. Operation

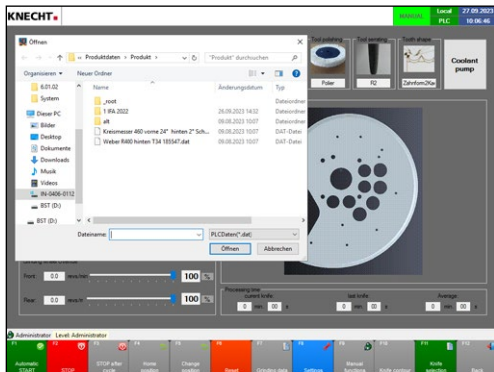

Figure 7-2 Loading a grinding program

Select the desired grinding program by double-clicking on the corresponding file. (Grinding programs have the file extension “.dat”).

The corresponding grinding program is now loaded and the “Open” dialog box closes.



Use the grinding program that matches the knife. An incorrect grinding program can damage the machine and the knife.



Figure 7-3 Main screen

The selected grinding program appears in the “File name” line (7-3/1) on the main screen.

Check the knife image (7-3/3), the abrasives used (7-3/4), (7-3/5) and, optionally, the polishing brush (7-3/6) and exchange them if necessary.

The images and data must match the abrasives used.



On the main screen, appears under the designation “Holder” (7-3/2) the number of the knife mounting plate that matches the grinding program. This number is engraved on the knife mounting plate.

Each knife and each grinding program may require individual abrasives.

7. Operation

7.2.2 Clamping the sickle-shaped knife

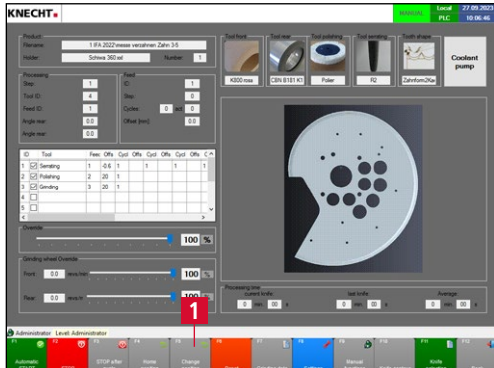

Figure 7-4 Main screen

Close the safety doors (3-2/7).

Move the axes with the touch panel field “Change position” (7-4/1) to the change position.

Open the safety doors.



Figure 7-5 Clamping nut

Move the clamping nut (7-5/1) to the rear as shown in the figure.

ATTENTION

Grease the thread, otherwise it may be damaged.

Before clamping the knife, check whether the knife mounting plate matches the knife to be ground. To do this, compare the inscription on the knife mounting plate with that on the knife. Using a knife mounting plate that does not fit can damage the knife and the grinding machine.

7. Operation

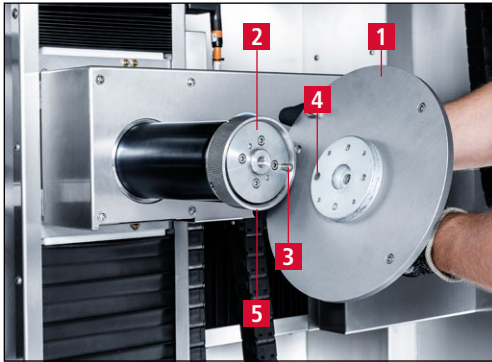

Figure 7-6 Mounting the knife mounting plate

Place the knife mounting plate (7-6/1) on the holding flange (7-6/2).

Insert the centering pin (7-6/3) into the centering hole (7-6/4) of the knife mounting plate.

Screw the clamping nut (7-6/5) onto the knife mounting plate (7-6/1).

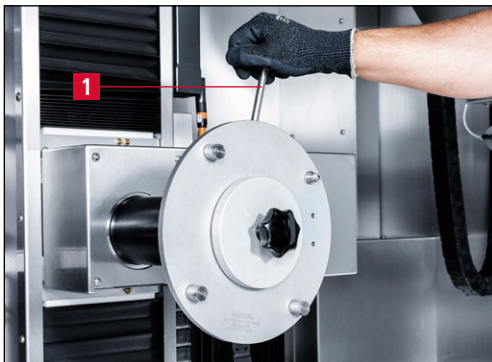

Figure 7-7 Tightening clamping nut

Tighten the clamping nut with the provided clamping bolt (7-7/1) firmly.

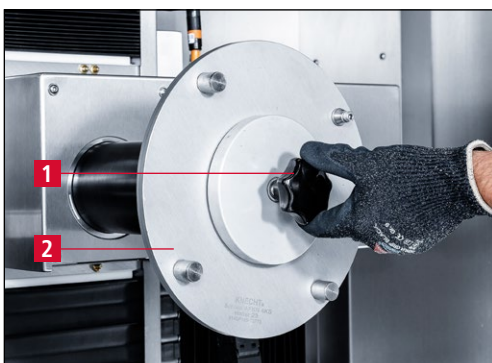

Figure 7-8 Removing the star knob

Remove the star knob (7-8/1) from the knife mounting plate (7-8/2).

7. Operation



Figure 7-9 Removing the clamping flange

Remove clamping flange (7-9/1).



Figure 7-10 Clamping the knife

Clamp knife (7-10/1) with mounted knife protector (7-10/2).



Never clamp the knife without protection.

Serious injuries are possible.



Figure 7-11 Placing the clamping flange

Place the clamping flange (7-11/1).

7. Operation



Figure 7-12 Tightening clamping flange

Then tighten the clamping flange slightly with the star knob (7-12/1) provided.

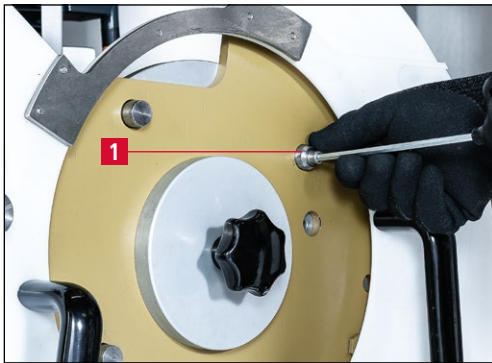

Figure 7-13 Tightening the knife

Tighten the knife on the knife mounting plate with the centering screw (7-13/1).

Tighten the clamping flange with the star knob (7-12/1).



Figure 7-14 Removing the knife protector

Remove the knife protector (7-14/1).

7. Operation

7.2.3 Grinding the sickle-shaped knife

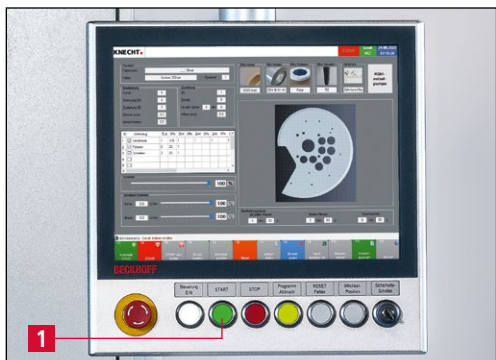

Figure 7-15 Control panel

Align coolant hoses (3-3/2) and open coolant supply.

Close safety doors (3-2/7).

Press the "START" button (7-15/1).



Figure 7-16 Grinding and deburring sickle-shaped knife

The grinding program starts (Figure 7-16).

7.2.4 Polishing the sickle-shaped knife (optional)



Figure 7-17 Polishing sickle-shaped knife

If the A95 is equipped with a polishing unit, the knife edge can be additionally polished after the grinding program.

The operator must activate this function in the grinding program (see Chapter 7.2.1). The polishing process starts automatically after the grinding process is completed.

7. Operation

7.3 Serrating / re-serrating sickle-shaped knives

7.3.1 Loading the grinding program

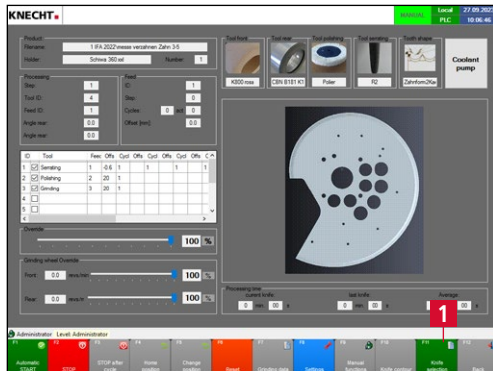

Figure 7-18 Main screen

Press the touch panel field “Knife selection” on the main screen (7-18/1). The “Open” dialog box appears.

The grinding programs are located in the “Product data” folder.

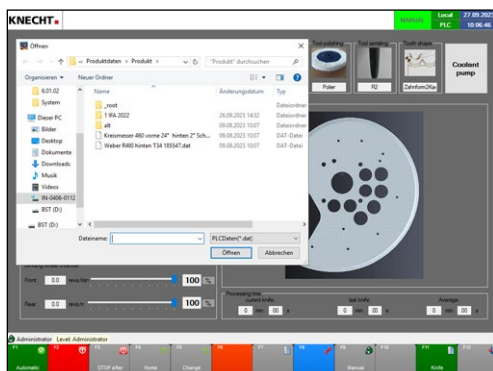

Figure 7-19 Loading a grinding program

Select the desired grinding program by double-clicking on the corresponding file. (Grinding programs have the file extension “.dat”).

The corresponding grinding program is now loaded and the “Open” dialog box closes.



Use the grinding program that matches the knife. An incorrect grinding program can damage the machine and the knife.

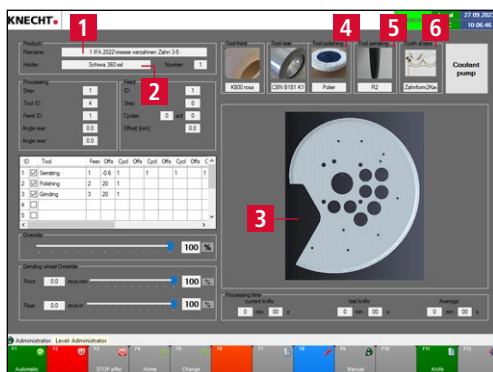

Figure 7-20 Main screen

The selected grinding program appears in the “File name” line (7-20/1) on the main screen.

Check the knife picture (7-20/3), the abrasives used (7-20/4), (7-20/5) and the tooth shape (7-20/6) and exchange them if necessary.

The images and data must match the abrasives used.

7. Operation

NOTE

The number of the knife mounting plate matching the grinding program appears on the main screen under the designation "Holder" (7-20/2). Each knife mounting plate is marked with the corresponding holder number.

Each knife and each grinding program may require individual abrasives.

7.3.2 Measuring the profiling wheel



Figure 7-21 Measuring the thickness of the profiling wheel

Before clamping the knife, the thickness of the profiling wheel must be measured with a caliper and, if necessary, corrected in the machine data (see Figure 7-22).

NOTE

If an incorrect thickness of the profiling wheel is stored in the machine data, an error message appears when the process is started.

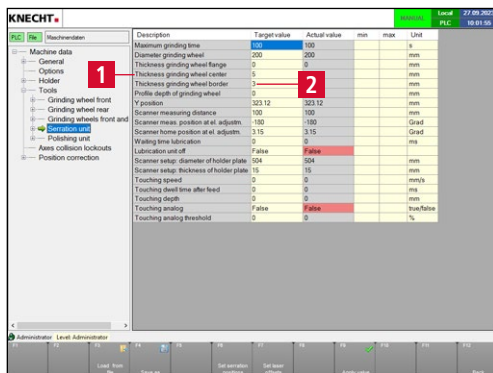

Figure 7-22 Settings – Machine data – Tools "Serration unit"

Under "Settings" (3-11/14) followed by "Machine data" (8-1/6), followed by "Tools – Serration unit", enter the thickness of the profiling wheel at the center hole (7-22/1) and the thickness of the profiling wheel at the grinding edge (7-22/2).

7. Operation

7.3.3 Clamping the sickle-shaped knife

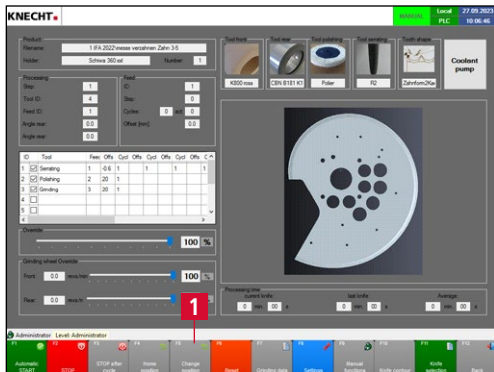

Figure 7-23 Main screen

Close the safety doors (3-2/7).

Move the axes with the touch panel field “Change position” (7-23/1) to the change position.

Open the safety doors.



Figure 7-24 Clamping nut

Move the clamping nut (7-24/1) to the rear as shown in the figure.

ATTENTION

Grease the thread, otherwise it may be damaged.

Before clamping the knife, check whether the knife mounting plate matches the knife to be ground. To do this, compare the inscription on the knife mounting plate with that on the knife. Using a knife mounting plate that does not fit can damage the knife and the grinding machine.

7. Operation

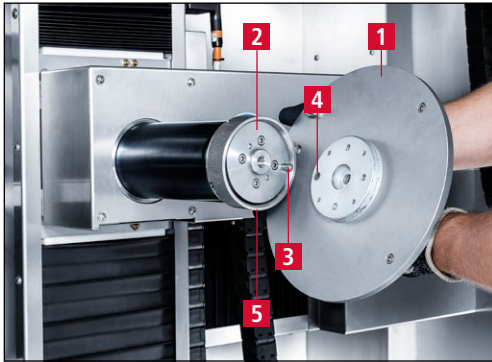

Figure 7-25 Mounting the knife mounting plate

Place the knife mounting plate (7-25/1) on the holding flange (7-25/2).

Insert the centering pin (7-25/3) into the centering hole (7-25/4) of the knife mounting plate.

Screw the clamping nut (7-25/5) onto the knife mounting plate (7-25/1).

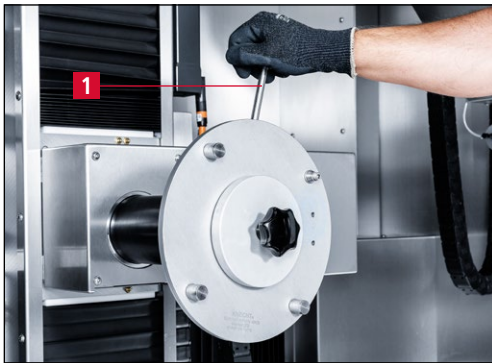

Figure 7-26 Tightening clamping nut

Tighten the clamping nut with the provided clamping bolt (7-26/1) firmly.

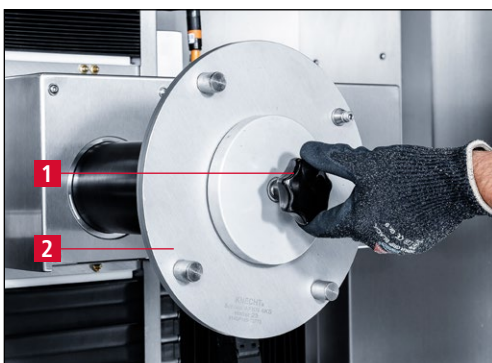

Figure 7-27 Removing the star knob

Remove the star knob (7-27/1) from the knife mounting plate (7-27/2).

7. Operation



Figure 7-28 Removing the clamping flange

Remove clamping flange (7-28/1).



Figure 7-29 Clamping the knife

Clamp knife (7-29/1) with mounted knife protector (7-29/2).



Never clamp the knife without protection.

Serious injuries are possible.



Figure 7-30 Placing the clamping flange

Place the clamping flange (7-30/1).

7. Operation



Figure 7-31 Tightening clamping flange

Then tighten the clamping flange slightly with the star knob (7-31/1) provided.



Figure 7-32 Tightening the knife

Tighten the knife on the knife mounting plate with the centering screw (7-32/1).

Tighten the clamping flange with the star knob (7-31/1).



Figure 7-33 Removing the knife protector

Remove the knife protector (7-33/1).

7. Operation

7.3.4 Serrating / re-serrating the sickle-shaped knife



Figure 7-34 Control panel

Align coolant hoses (3-3/2) and open coolant supply.

Close safety doors (3-2/7).

Press the "START" button (7-34/1).



Figure 7-35 Serrating sickle-shaped knife

The serration program starts (Figure 7-35).

7.3.5 Polishing the serrated sickle-shaped knife



Figure 7-36 Polishing sickle-shaped knife

The polishing process must be activated in the grinding program (see Chapter 7.3.1).

Then the polishing process starts fully automatically after the serration process has been completed.

7. Operation

7.4 Grinding circular knives

7.4.1 Loading the grinding program

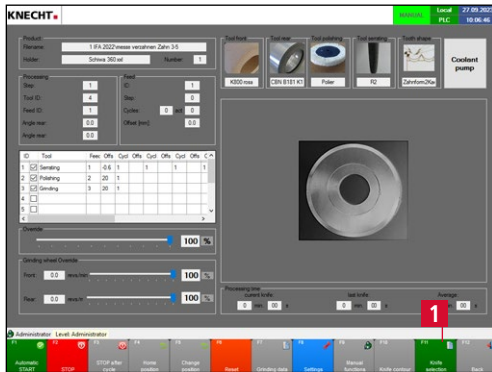

Figure 7-37 Main screen

Press the touch panel field “Knife selection” (7-37/1) on the main screen. The “Open” dialog box appears.

The grinding programs are located in the “Product data” folder.

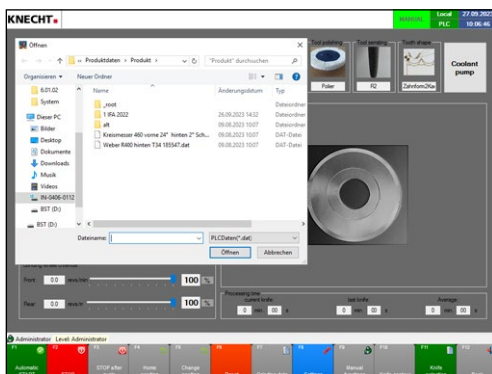

Figure 7-38 Loading a grinding program

Select the desired grinding program by double-clicking on the corresponding file. (Grinding programs have the file extension “.dat”).

The corresponding grinding program is now loaded and the “Open” dialog box closes.



Use the grinding program that matches the knife. An incorrect grinding program can damage the machine and the knife.

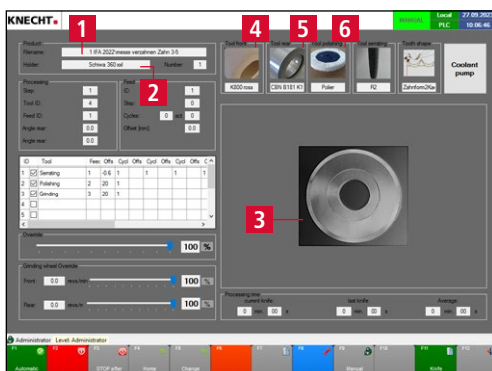

Figure 7-39 Main screen

The selected grinding program appears in the “File name” line (7-39/1) on the main screen.

Check the knife picture (7-39/3), the abrasives used (7-39/4), (7-39/5) and optionally the polishing brush (7-39/6) and exchange them if necessary.

The images and data must match the abrasives used.

7. Operation

NOTE

The number of the knife mounting plate matching the grinding program appears on the main screen under the designation "Holder" (7-39/2). Each knife mounting plate is marked with the corresponding holder number.

Each knife and each grinding program may require individual abrasives.

7.4.2 Clamping the circular knife

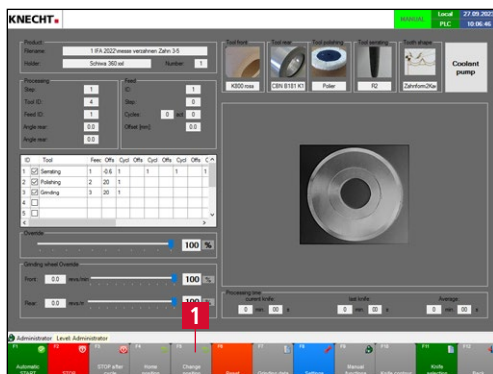

Figure 7-40 Main screen

Close the safety doors (3-2/7).

Move the axes with the touch panel field "Change position" (7-40/1) to the change position.

Open the safety doors.



Figure 7-41 Clamping nut

Move the clamping nut (7-41/1) to the rear as shown in the figure.

ATTENTION

Grease the thread, otherwise it may be damaged.

Before clamping the knife, check whether the knife mounting plate matches the knife to be ground. To do this, compare the inscription on the knife mounting plate with that on the knife. Using a knife mounting plate that does not fit can damage the knife and the grinding machine.

7. Operation

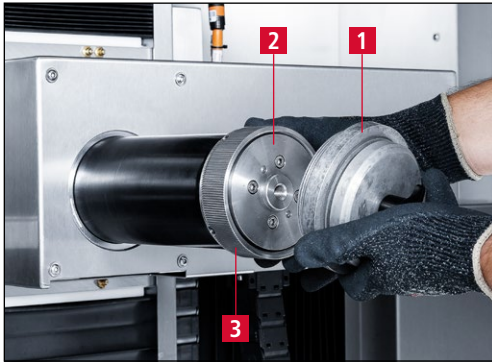

Figure 7-42 Mounting the knife mounting plate

Place the knife mounting plate (7-42/1) on the holding flange (7-42/2).

Screw the clamping nut (7-42/3) onto the knife mounting plate.

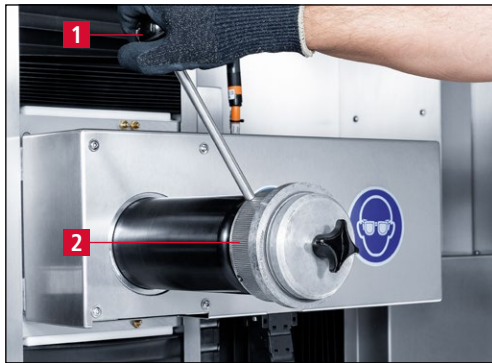

Figure 7-43 Tightening clamping nut

Tighten the clamping nut (7-43/2) with the provided clamping bolt (7-43/1) firmly.

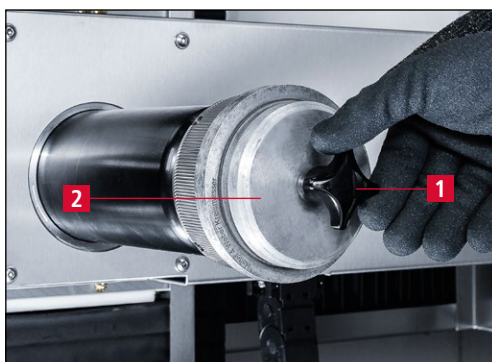
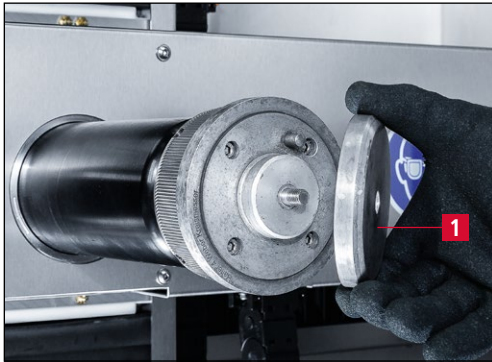

Figure 7-44 Removing the star handle

Remove the star handle (7-44/1) from the knife mounting plate (7-44/2).

7. Operation



Remove clamping flange (7-45/1).

Figure 7-45 Removing the clamping flange



Clamp the knife (7-46/1) with mounted knife protector (7-46/2).

Figure 7-46 Clamping the knife



Never clamp the knife without protection.

Serious injuries are possible.



Place the clamping flange (7-47/1).

Figure 7-47 Placing the clamping flange

7. Operation

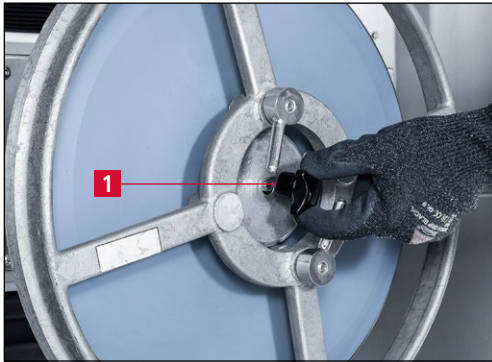

Figure 7-48 Tightening the clamping flange

Then tighten the clamping flange with the star handle (7-48/1) provided.



Figure 7-49 Removing the knife protector

Remove the knife protector (7-49/1).

7.4.3 Grinding the circular knife



Figure 7-50 Control panel

Align coolant hoses (3-3/2) and open coolant supply.

Close safety doors (3-2/7).

Press the "START" button (7-50/1).

7. Operation



Figure 7-51 Grinding circular knives

The grinding program starts (Figure 7-51).

7.4.4 Polishing the circular knife (optional)

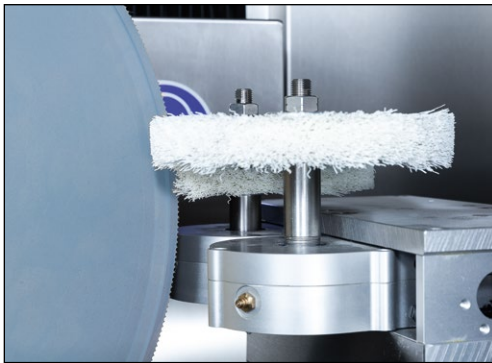

Figure 7-52 Polishing circular knives

If the A95 is equipped with a polishing unit, the knife edge can be additionally polished after the grinding program.

The operator must activate this function in the grinding program (see Chapter 7.4.1). Then the polishing process starts automatically after the grinding process is completed.

7. Operation

7.5 Serrating / re-serrating circular knives

7.5.1 Loading the grinding program

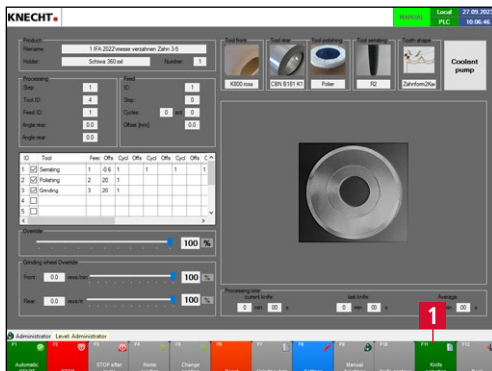

Figure 7-53 Main screen

Press the touch panel field “Knife selection” (7-53/1) on the main screen. The “Open” dialog box appears.

The grinding programs are located in the “Product data” folder.

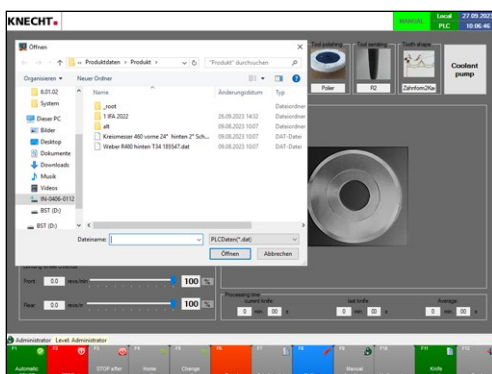

Figure 7-54 Loading a grinding program

Select the desired grinding program by double-clicking on the corresponding file. (Grinding programs have the file extension “.dat”).

The corresponding grinding program is now loaded and the “Open” dialog box closes.



Use the grinding program that matches the knife. An incorrect grinding program can damage the machine and the knife.

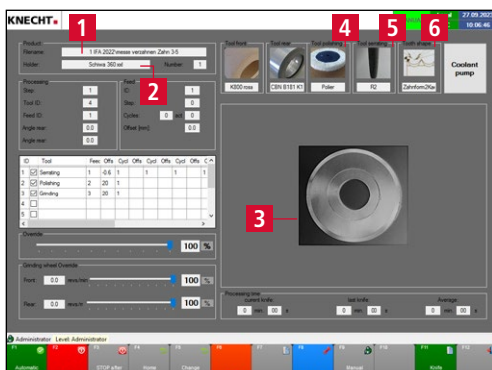

Figure 7-55 Main screen

The selected grinding program appears in the “File name” line (7-55/1) on the main screen.

Check the knife picture (7-55/3), the abrasives used (7-55/4), (7-55/5) and the “tooth shape” (7-55/6) and exchange them if necessary.

The images and data must match the abrasives used.

7. Operation

NOTE

On the main screen, the number of the knife mounting plate matching the grinding program appears under the designation "Holder" (7-55/2). Each knife mounting plate is marked with the corresponding holder number.

Each knife and each grinding program may require individual abrasives.

7.5.2 Measuring the profiling wheel



Figure 7-56 Measuring the thickness of the profiling wheel

Before clamping the knife, the thickness of the profiling wheel must be measured with a caliper and, if necessary, corrected in the machine data (see Figure 7-57).

NOTE

If an incorrect thickness of the profiling wheel is stored in the grinding program, an error message appears when the process is started.

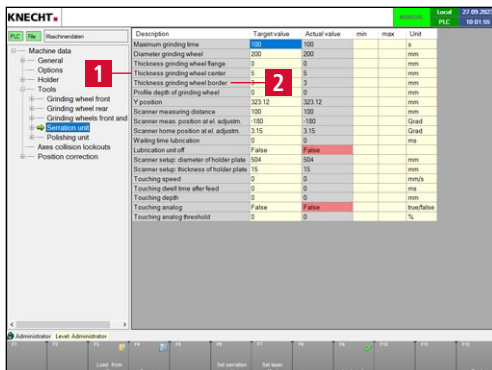

Figure 7-57 Settings – Machine data – Tools "Serration unit"

Under "Settings" (3-11/14) followed by "Machine data" (8-1/6) followed by "Tools" – "Serration unit", enter the thickness of the profiling wheel at the center hole (7-57/1) and the thickness of the profiling wheel at the grinding edge (7-57/2).

7. Operation

7.5.3 Clamping the circular knife

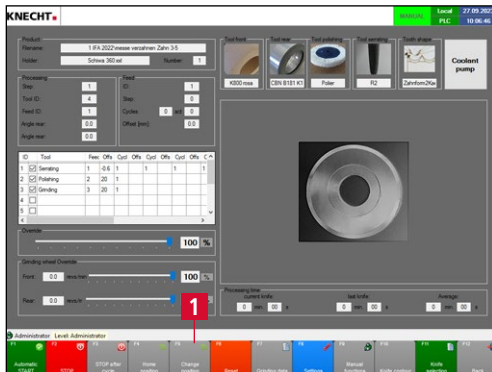

Figure 7-58 Main screen

Close the safety doors (3-2/7).

Move the axes with the touch panel field "Change position" (7-58/1) to the change position.

Open the safety doors.



Figure 7-59 Clamping nut

Move the clamping nut (7-59/1) to the rear as shown in the figure.

ATTENTION

Grease the thread, otherwise it may be damaged.

Before clamping the knife, check whether the knife mounting plate matches the knife to be ground. To do this, compare the inscription on the knife mounting plate with that on the knife. Using a knife mounting plate that does not fit can damage the knife and the grinding machine.

7. Operation

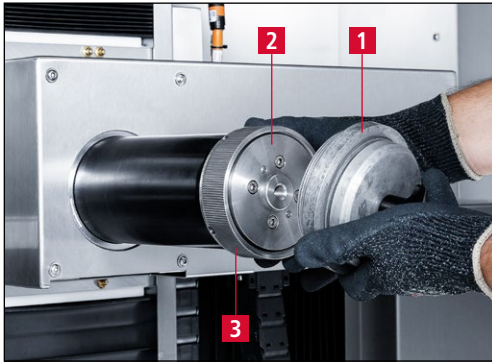

Figure 7-60 Mounting the knife mounting plate

Place the knife mounting plate (7-60/1) on the holding flange (7-60/2).

Screw the clamping nut (7-60/3) onto the knife mounting plate.

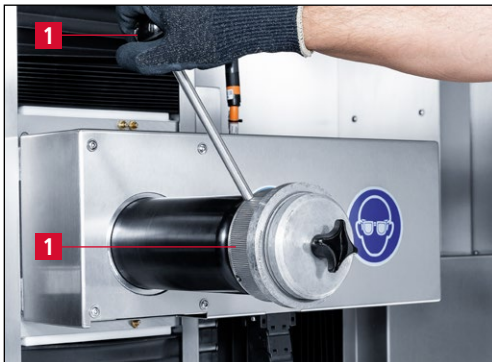

Figure 7-61 Tightening clamping nut

Tighten the clamping nut (7-61/2) with the provided clamping bolt (7-61/1) firmly.

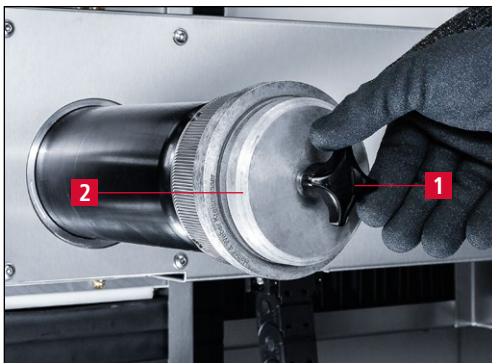
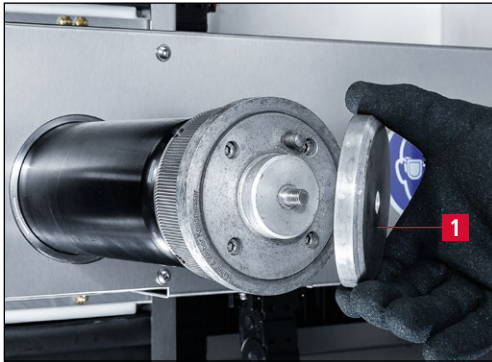

Figure 7-62 Removing the star handle

Remove the star handle (7-62/1) from the knife mounting plate (7-62/2).

7. Operation



Remove clamping flange (7-63/1).

Figure 7-63 Removing the clamping flange



Clamp the knife (7-64/1) with mounted knife protector (7-64/2).

Figure 7-64 Clamping the knife



Never clamp the knife without protection.

Serious injuries are possible.



Place the clamping flange (7-65/1).

Figure 7-65 Placing the clamping flange

7. Operation

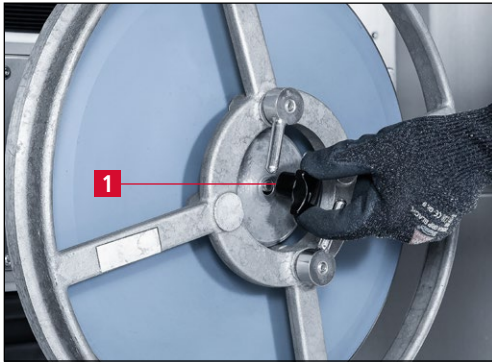

Figure 7-66 Tightening the clamping flange

Then tighten the clamping flange with the star handle (7-66/1) provided.



Figure 7-67 Removing the knife protector

Remove the knife protector (7-67/1).

7.5.4 Serrating / re-serrating the circular knife



Figure 7-68 Control panel

Align coolant hoses (3-3/2) and open coolant supply.

Close safety doors (3-2/7).

Press the "START" button (7-68/1).

7. Operation

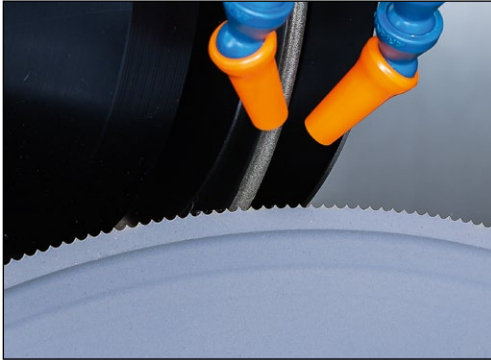

Figure 7-69 Serrating circular knives

The serration program starts (Figure 7-69).

7.5.5 Polishing the serrated circular knife

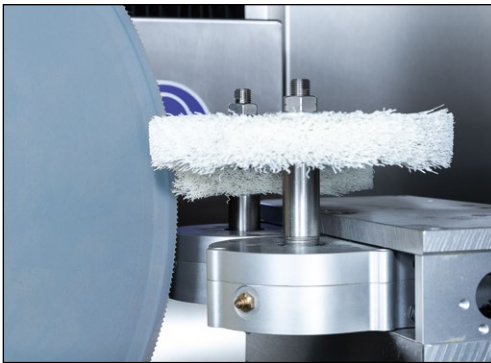

Figure 7-70 Polishing circular knife

The polishing process must be activated in the grinding program (see Chapter 7.5.1).

Then the polishing process starts fully automatically after the serration process has been completed.

7. Operation

7.6 Positioning the polishing unit (optional)



Figure 7-71 Positioning the polishing unit

If required, the polishing unit can be positioned optimally to the knife edge.

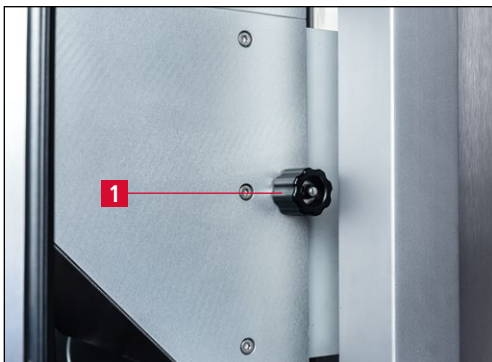

Figure 7-72 Adjustment knob for positioning the polishing unit

This is done by turning the adjusting knob (7-72/1) on the front of the polishing unit.

7. Operation

7.7 Changing the front/rear grinding wheels

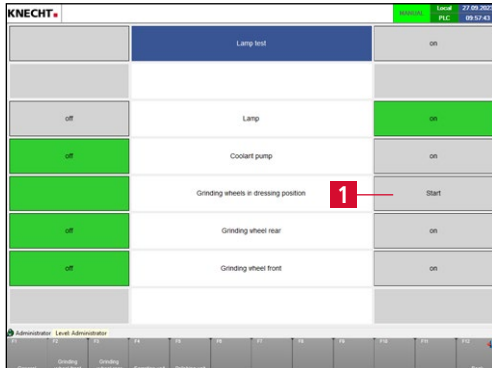

Figure 7-73 Manual functions

Close the safety doors.

Via the main menu "Manual functions" (3-11/15) you can access the general manual functions.

Move the grinding wheels to the dressing position with the touch panel field "Start" (7-73/1).

Open the safety doors.

ATTENTION

Set the "Set-up mode" key switch (3-10/9) to position "1".



Figure 7-74 Changing the grinding wheels

With a hexagon screwdriver AF6 mm, loosen the screw in the center of the grinding wheel (7-74/1) counterclockwise and remove it.

Remove the front or rear grinding wheel and mount the new grinding wheel in reverse order.

ATTENTION

Only original abrasives from KNECHT Maschinenbau GmbH are permitted to be used.

KNECHT Maschinenbau GmbH assumes no responsibility for the use of non-original abrasives.

7. Operation

7.7.1 Intermediate flange for ceramic grinding wheels

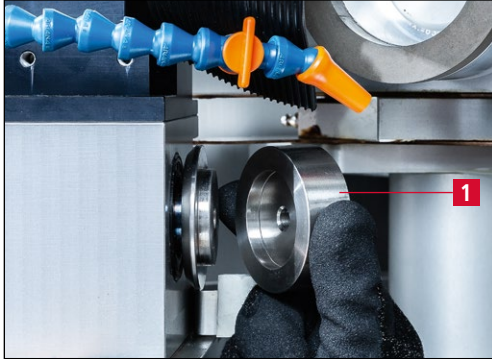

Figure 7-75 Mounting the intermediate flange

If ceramic grinding wheels are used, an intermediate flange (7-75/1) must be mounted from a wear of 50% (less than 40 mm grinding wheel thickness).

Use the M8x40 cylinder head screw supplied for this purpose.

NOTE

Two intermediate flanges with the corresponding screws are included in the scope of delivery.

7. Operation

7.8 Changing the profiling wheel (optional)



Figure 7-76 Removing the protection hood

Loosen the star handle (7-76/1).

Remove the protection hood (7-76/2).

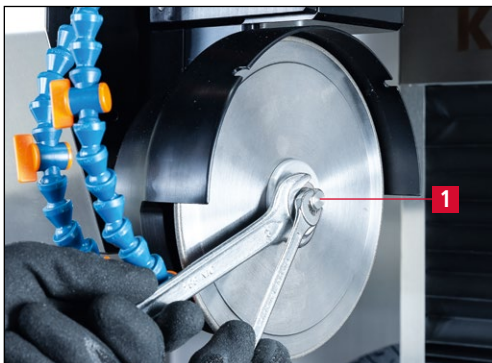

Figure 7-77 Loosening the clamping nuts

Open and remove the two hexagon nuts (7-77/1) of the profiling wheel counterclockwise using an open-end wrench AF22 mm. Fix the shaft with the AF 10mm open-end wrench.

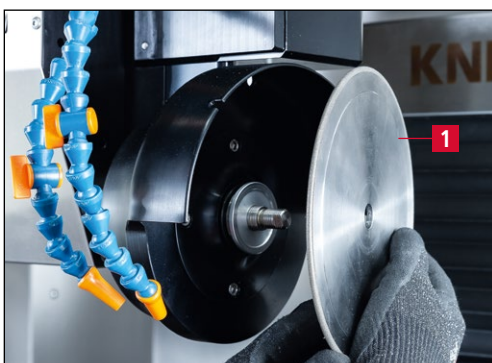

Figure 7-78 Changing the profiling wheel

Remove the profiling wheel (7-78/1) and mount the new one in reverse order.

Mount the protection hood (7-76/2) and tighten the star handle (7-76/1).

ATTENTION

Only original abrasives from KNECHT Maschinenbau GmbH are permitted to be used.

7. Operation

ATTENTION

KNECHT Maschinenbau GmbH assumes no responsibility for the use of non-original abrasives.

7. Operation



Danger of clothing and hair being pulled in. Crushing hazard for hands. Serious injuries are possible.

To prevent dust formation, only dress the grinding wheel when coolant is supplied.

Never dress with the knife clamped. Serious cutting injuries are possible.

Dressing produces abrasive particles that can enter the eyes. Wear safety glasses.

7.9 Dressing ceramic grinding wheels front/rear

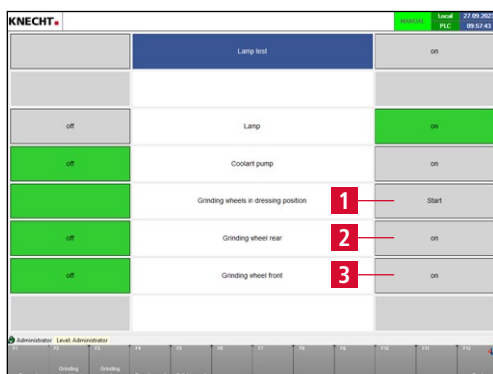

Figure 7-79 Manual functions

If the front grinding wheel runs out of round or is clogged, it must be dressed.

Close the safety doors.

Switch to the general manual functions via the main menu "Manual functions" (3-11/15).

Move the grinding wheels to the dressing position with the touch panel field "Start" (7-79/1).

ATTENTION

Set the key switch "Set-up mode" (3-10/9) to position "1".

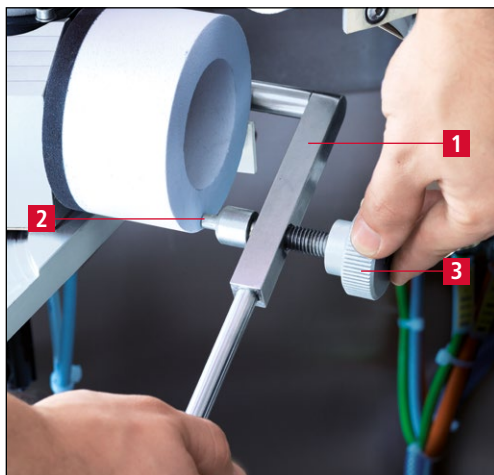

Figure 7-80 Dressing the front grinding wheel

Open the safety doors.

Insert the truing device (7-80/1) into the designated socket of the front grinding unit as far as it will go.

Switch on the front grinding wheel.

To do this, press the touch panel field "on" (7-79/3) in the "Manual functions".

Move the dressing diamond (7-80/2) with the dressing device evenly over the rotating grinding wheel.

The dressing diamond is fed in by turning the feed nut (7-80/3) clockwise.

7. Operation

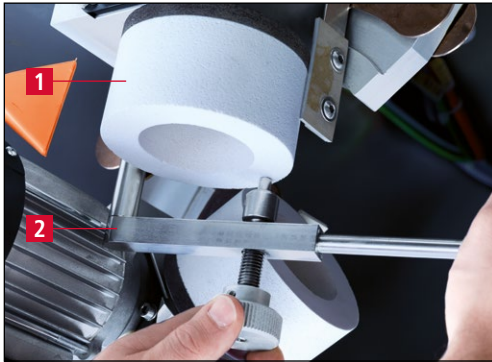

Figure 7-81 Dressing the rear grinding wheel

Insert the truing device (7-81/2) into the designated socket of the rear grinding unit as far as it will go.

Switch on the rear grinding wheel (7-81/1).

To do this, press the touch panel field "on" (7-79/2) in the "Manual functions".

Dress the grinding wheel as described in Figure 7-80.

8. Control

8.1 Settings

Settings that go beyond the basic functions “Start” or “Stop” of the machine, are carried out in the main menu “Settings” (3-11/14).

ATTENTION

Changes to the settings can damage the machine.



Figure 8-1 Settings

- 1 Processing time (current knife, last knife and average in min./sec.)
- 2 **“Serrating”**: prepare serrating of the knife
- 3 **“Axes manual mode”**: move axes individually in manual mode; see Chapter 8.3.
- 4 **“Reset processing time”**: reset machining time
- 5 **“Grinding data”**: set knife-dependent grinding data; see Chapter 8.4
- 6 **“Machine data”**: display/edit factory-set machine data
- 7 **“Holder data”**: display/edit holder data
- 8 **“Manual functions”**: permits manual operation of the machine; see Chapter 8.5
- 9 **“Message texts”**: displays all error messages continuously (number, frequency, start; see Chapter 8.6)
- 10 **“Options”**: change language etc.; see Chapter 8.7
- 11 **“Back”**: switch to the previous display

8. Control

8.2 Serrating (re-serrating)

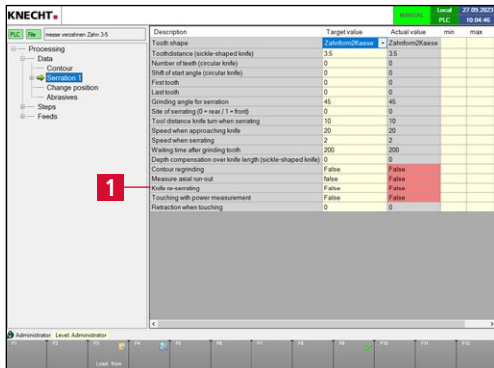

Figure 8-2 Grinding data – Data – Serration



In order to be able to re-serrate a knife, the parameter “Knife re-serrating” (8-2/1) must be set to “True” in the “Grinding data” submenu (see Chapter 8.4) (here set to “False”).

Before starting the program, switch to the “Serrating” submenu (8-4) via “Settings” (3-11/14).

Set “Measure” to active with “active / inactive” (8-4/6) and “Serrating” to active with “active / inactive” (8-4/9).

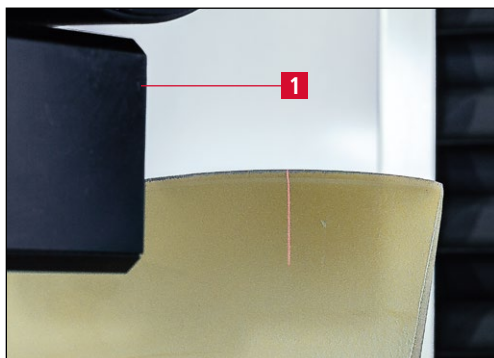

Figure 8-3 Laser in waiting position

After activation, the program is started with “Automatic START” (3-11/7).

The laser (8-3/1) remains in the waiting position in front of the knife to wait for the manual setting of the tooth position.

Switch to the “Serrating” (8-4) submenu via “Settings” (3-11/14).

8. Control

The position and grinding depth of the tooth can be set here:

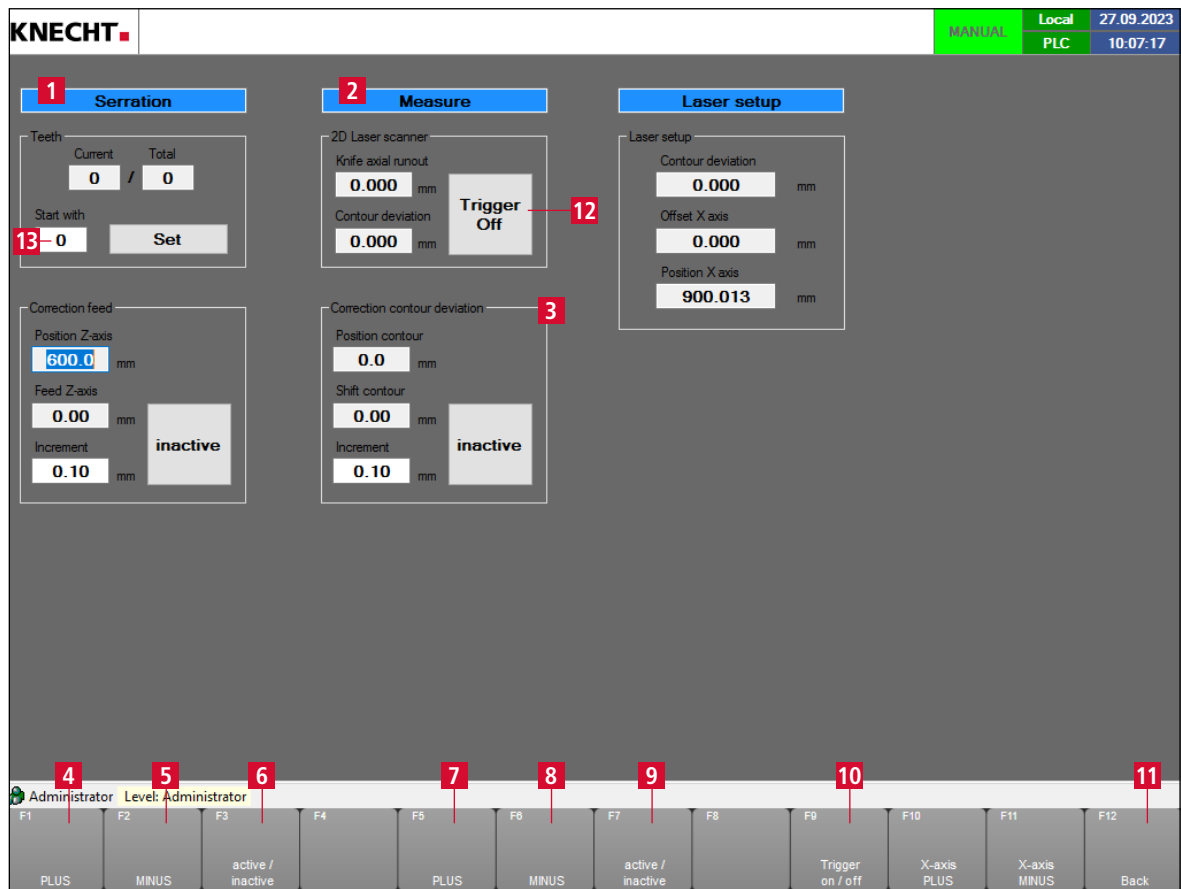

Figure 8-4 Settings – Serrating

First position of the tooth: Press “Trigger on/off” (8-4/10) until the “Trigger Off” field (8-4/12) is highlighted in green. Move to the highest point of the first tooth with “PLUS” (8-4/7) and “MINUS” (8-4/8) (visible via red laser line (Figure 8-3) and in the contour deviation display (8-4/3)). Acknowledge with “active/inactive” (8-4/9).

The program moves the complete knife and measures the teeth.

The knife stops at the lowest first point. Set the grinding depth with “PLUS” (8-4/4) and “MINUS” (8-4/5).

Finally, start the re-serrating program with “active/inactive” (8-4/6).

ATTENTION

Before laser measurement starts, the cutting edge must be carefully cleaned of any dirt.

NOTE

The “active / inactive” touch panel field (8-4/6) can also be activated during serrating in order to regrind a single tooth.

8. Control

NOTE

The "Start with" parameter (8-4/13) can be used to grind the knife from a specific tooth. The machine moves to this tooth after "Automatic START" (3-11/7) and then waits for the alignment and depth to be set manually.

8. Control

8.3 Axes manual operation

Via the main menu "Settings" (3-11/14) the submenu "Axis manual mode" (8-1/3) is called. The "Axis manual mode" display (8-5) shows the axis positions of the CNC-controlled machine axes. In addition, the axes can be controlled manually.



Figure 8-5 Settings – Axes

- 1 "--": movement of the selected axis in direction "--" (backward) in rapid traverse
- 2 "-": movement of the selected axis in the "-" direction (backward)
- 3 "+": movement of the selected axis in direction "+" (forward)
- 4 "++": movement of the selected axis in direction "+" (forward) in rapid traverse
- 5 "START": move to target position according to entered axis movement
- 6 "STOP": interrupt positioning
- 7 "Set Axis Positions": menu for setting the axes during commissioning
- 8 "Back": switch to the previous display

8. Control

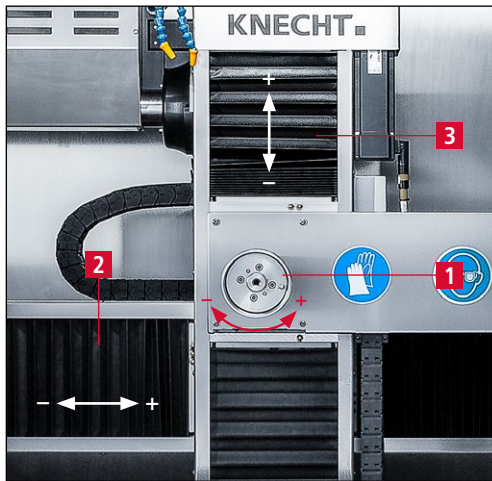

Figure 8-6 Axes

The horizontal movement of the knife holding flange is the X-axis (8-6/2). The vertical movement is the Z-axis (8-6/3).

The rotary movement of the knife holding flange is the B-axis (8-6/1).

The angular movement of the rear grinding wheel is "Grinding back" (8-5/11). That of the front grinding wheel is "Grinding front" (8-5/10).

For a manual axis movement, select the desired axis on the touch panel. The selected axis is highlighted in blue.

With the touch panel fields "--" (8-5/1), "-" (8-5/2), "+" (8-5/3) and "++" (8-5/4) the axes can be moved.

8. Control

8.4 Grinding data

The submenu "Grinding data" (8-1/5) is called up via the main menu "Settings" (3-11/14). In the "Grinding data" (8-7) display, data for the grinding process is entered. These data are knife-dependent. The data are saved in a file and can be reloaded from the file.

ATTENTION

Changes to the grinding data can lead to malfunctions and machine damage.

Changes may only be carried out by KNECHT technicians, or under the supervision of KNECHT technicians or by persons authorized by KNECHT Maschinenbau.

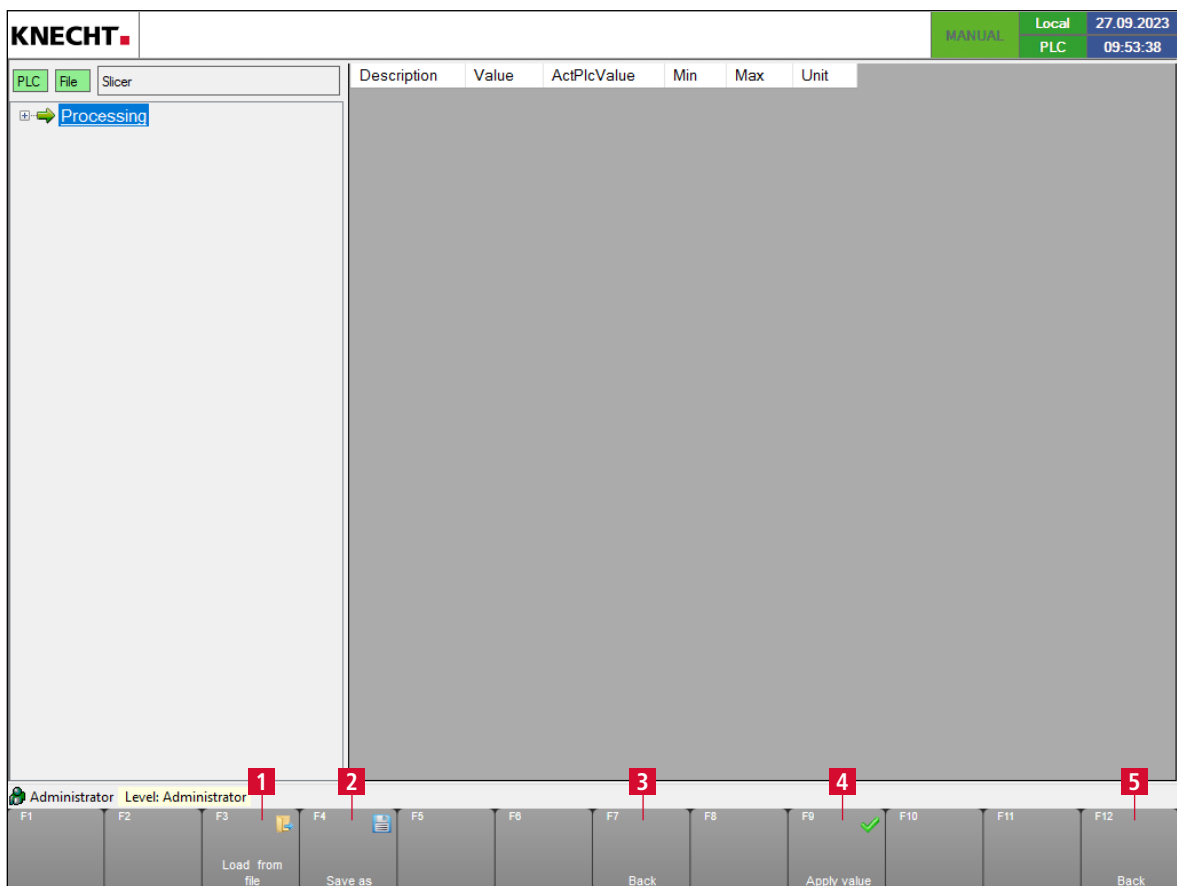

Figure 8-7 Grinding data

- 1 "Load from file"
- 2 "Save as"
- 3 "Back"
- 4 "Apply value"
- 5 "Back": switch to the previous display

8. Control

8.4.1 Data

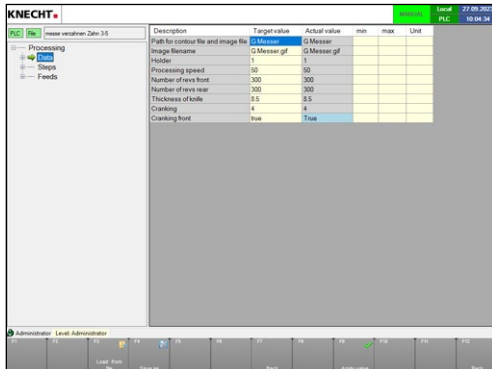

Figure 8-8 Grinding data "Data"

Path for contour file and image file: Names the subdirectory where the contour description file and image file of the knife are located. The complete path is mapped in the control (Example: knife small = C:\Knecht\VISU\Productdata\Knife small).

Image file name: file name of the knife picture (file extension ".gif").

Holder: index on which holder the knife is processed (suitable holder data are set in the settings under "Holder data" (8-1/7))

Processing speed: machining speed at which the knife rotates during grinding (mm/s)

Number of revs front

Number of revs rear

Thickness of knife: thickness of the knife

Cranking: crank of the cutting edge to the holder

Cranking front: true = crank to front, false = crank to rear

8.4.2 Data – Contour

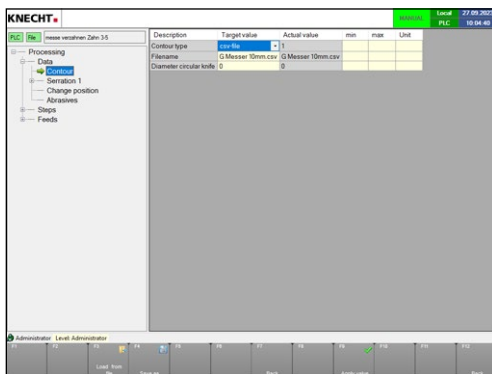

Figure 8-9 Grinding data "Data – Contour"

Contour type: Contour description type of the knife: 1 = ".csv" file with two-dimensional xy-contour, 2 = circular knife, 3 = knife with different straight cutting segments, 4 = no knife. This is also described in a ".csv" file.

Filename: file name of the knife contour (file extension ".csv")

Diameter circular knife: diameter of the circular knife to be ground

8. Control

8.4.3 Data – Serration

Description	Target value	Actual value	min	max
Tooth shape	Zahnrund/Klasse	Zahnrund/Klasse		
Tooth distance (sickle-shaped knife)	35	35		
Number of teeth (circular knife)	0	0		
Shift of start angle (circular knife)	0	0		
First tooth	0	0		
Last tooth	0	0		
Grinding angle for serration	45	45		
Site of serrating (0 = rear / 1 = front)	0	0		
Tool distance knife turn when serrating	10	10		
Speed when approaching knife	20	20		
Speed when serrating	2	2		
Waiting time after grinding tooth	200	200		
Depth compensation over knife length (sickle-shaped knife)	0	0		
Contour regrinding	False	False		
Measure axial run-out	False	False		
Knife re-serrating	False	False		
Touching with power measurement	False	False		
Retraction when touching	0	0		

Figure 8-10 Grinding data “Data – Serration”

Tooth shape: the tooth shape is selected here

Tooth distance (sickle-shaped knife): Distance between the teeth

Number of teeth (circular knife): number of teeth over which the tooth distance is determined for the circular knife

Shift of start angle (circular knife): start angle by which the first tooth is shifted

First tooth: tooth from which the serration starts

Last tooth: tooth from which serration ends

Grinding angle for serration: cutting edge angle at which the profiling wheel plunges into the knife during serration

Site of serrating (0 = rear, 1 = front): side from which serration is performed

Tool distance knife turn when serrating: distance between knife and profiling wheel during rotation

Speed when approaching knife: speed at which the knife is approached

Speed when serrating: speed at which serration is performed

Waiting time after grinding tooth: waiting time before the profiling wheel is moved out upwards

Depth compensation over knife length (sickle-shaped knife): adaptation of the tooth depth over the entire cutter length

Contour regrinding: regrinding the knife contour with the profiling wheel

Measure axial run-out: measuring axial runout and knife contour before serrating

Knife re-serrating: before re-serrating, the value must be set to “True”

Touching with power measurement: probing via grinding wheel (without laser)

Retraction when touching: value for probing the next tooth when probing via grinding wheel

8. Control

8.4.4 Data – Change position

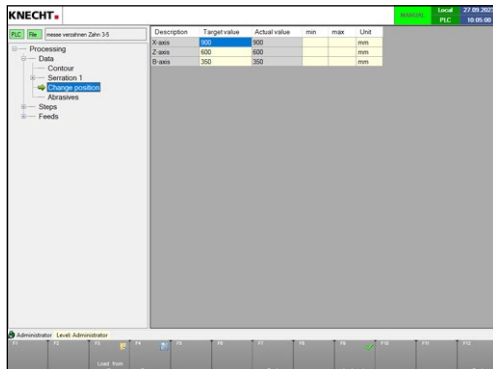

Figure 8-11 Grinding data “Data – Change position”

X-axis: position of the X-axis (horizontal)

Z-axis: position of the Z-axis (vertical)

B-axis: position of the B-axis (rotation)

8.4.5 Data – Abrasives

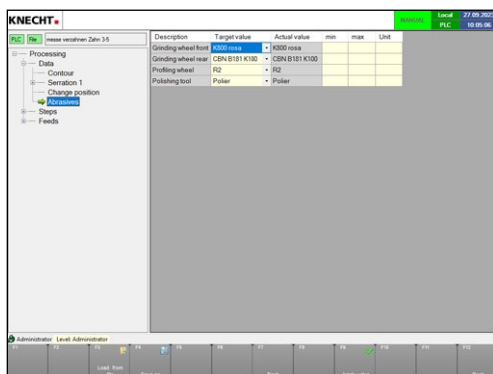

Figure 8-12 Grinding data “Data – Abrasives”

Grinding wheel front: selection of the front grinding wheel

Grinding wheel rear: selection of the rear grinding wheel

Profiling wheel: selection of the profiling wheel

Polishing wheel: selection of polishing wheel

8.4.6 Steps – Step 1

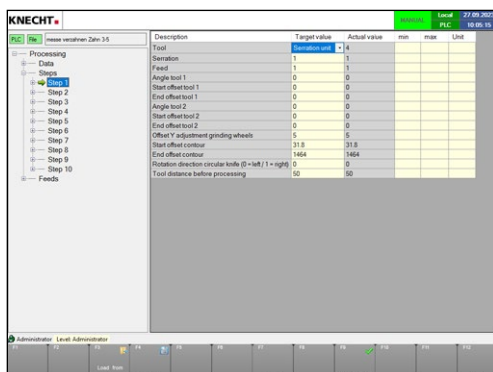

Figure 8-13 Grinding data “Steps – Step 1”

Tool: selection of the abrasives

Serration: input of the serration process

Feed: number of the infeed used for this step

Angle tool 1: angle adjustment front grinding wheel

Start offset tool 1: distance at which the front grinding wheel touches down on the knife at the contour start

End offset tool 1: distance at which the front grinding wheel lifts before the end of the contour

Angle tool 2: angle adjustment of rear grinding wheel

Start offset tool 2: distance at which the rear grinding wheel touches down on the knife at the start of the contour

8. Control

End offset tool 2: distance at which the rear grinding wheel lifts off before the end of the contour

Offset Y adjustment grinding wheels: positioning of the grinding wheels (via the Y-axis) relative to the knife edge

Start offset contour: definition of the start position of the grinding process

End offset contour: definition of the end position of the grinding process

Rotation direction circular knife (0 = left / 1 = right): specifies the rotating direction of a circular knife during machining

Tool distance before processing: safety clearance between knife and grinding wheels before machining

8.4.7 Feeds – Feed 1 – Steps – Step 1

Description	Target value	Actual value	min	max	Unit
Cycles	1				
Position	0.6	0.6			

Figure 8-14 Grinding data “Feeds – Feed 1 – Steps – Step 1”

Cycles: number of grinding processes that are performed with this infeed

Position: Knife distance to the grinding wheel during the grinding process. The decisive factors here are the tool positions entered in the machine data for the respective tool (“+” = away from the tool, “-” = towards the tool).

8. Control

8.5 Manual functions

The manual functions permit manual operation of the machine. They are called up via the main menu "Settings" (3-11/14), followed by "Manual functions" (8-1/8). Various functions of the grinding machine can be operated individually.

ATTENTION

Buttons highlighted in green are active.
Buttons highlighted in gray are inactive

NOTE

The manual functions are not required during regular operation. During maintenance work (e.g. grinding wheel change), the individual machine components can be moved into a maintenance-friendly position with the manual functions.

8.5.1 General

If the "Manual functions" submenu (8-1/8) has been called up, the display first changes to the general manual functions (8-15).



Figure 8-15 Manual functions "General"

8. Control

- 1 Switch on all lamps
- 2 Switch machine lamps on/off
- 3 Switch the coolant pump on/off
- 4 Move the grinding wheels to the dressing position
- 5 Switch the rear grinding wheel on/off
- 6 Switch the front grinding wheel on/off
- 7 **"General"** (current display)
- 8 **"Grinding wheel front"**: see Chapter 8.5.2
- 9 **"Grinding wheel rear"**: see Chapter 8.5.3
- 10 **"Serration unit"**: see Chapter 8.5.4
- 11 **"Polishing unit"**: see Chapter 8.5.5
- 12 **"Back"**: switch to the previous display

8.5.2 Grinding wheel front

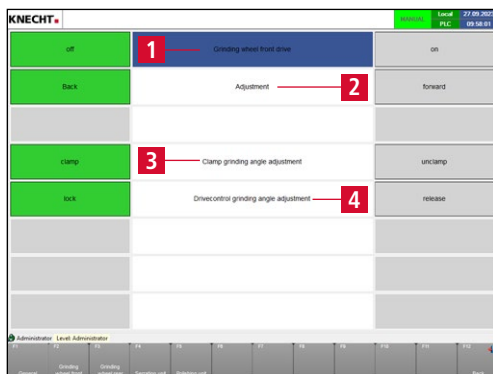

Figure 8-16 Manual functions "Grinding wheel front"

- 1 Switch the front grinding wheel drive on/off
- 2 Move angle adjustment forward/backward
- 3 Release/clamp angle adjustment clamp
- 4 Enable/disable motor for angle adjustment

8.5.3 Grinding wheel rear

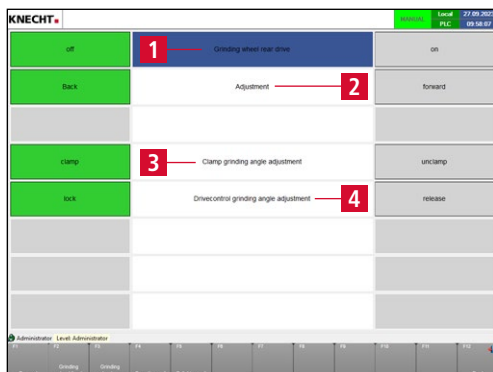

Figure 8-17 Manual functions "Grinding wheel rear"

- 1 Switch the rear grinding wheel drive on/off
- 2 Move angle adjustment forward/backward
- 3 Release/clamp angle adjustment clamp
- 4 Enable/disable motor for angle adjustment

8. Control

8.5.4 Serration unit

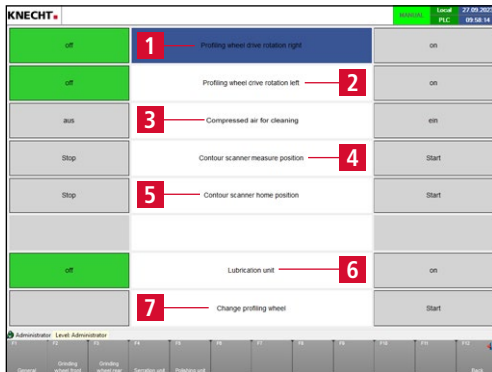

Figure 8-18 Manual functions "Serration unit"

- 1 Switch profiling wheel drive clockwise rotation on/off
- 2 Switch profiling wheel drive counterclockwise rotation on/off
- 3 Switch compressed air for cleaning on/off
- 4 Move contour scanner to measuring position
- 5 Move contour scanner to home position
- 6 Switch minimum quantity lubrication on/off
- 7 Change profiling wheel

8.5.5 Polishing unit

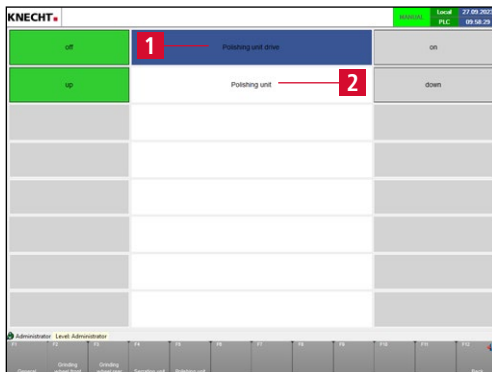

Figure 8-19 Manual functions "Polishing unit"

- 1 Switch polishing wheel drive on/off
- 2 Move polishing unit up/down

8. Control

8.6 Message texts

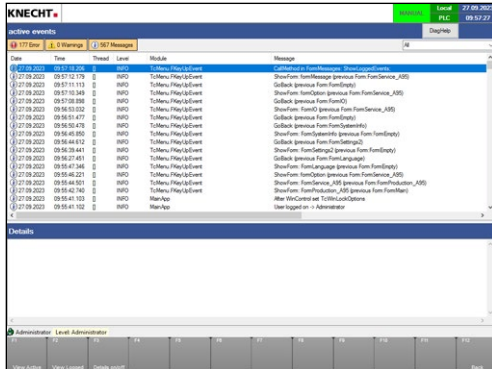

Figure 8-20 Message texts

The message texts display (8-20) is used exclusively for the detailed display of the status messages of the machine.

It provides an overview of how many errors are currently preventing the machine from operating properly. In addition, the submenu provides information about which errors have occurred and since when they have been active.

NOTE

No settings can be made in the message texts submenu. The errors also appear in the upper part of the main screen (3-11/1).

8.7 Options

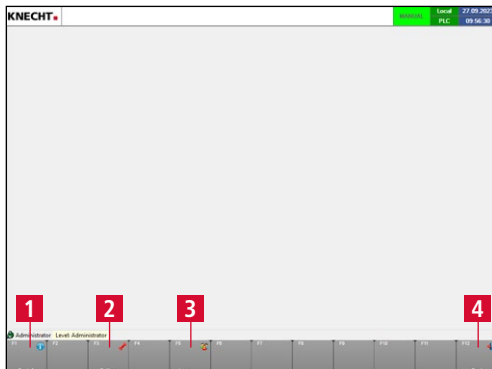

Figure 8-21 Options

- 1 "Sysinfo"
- 2 "Settings"
- 3 "Language": change language
- 4 "Back": switch to the previous display

8. Control

8.8 Knife contour

Figure 8-22 shows the knife contour calculated from the contents of the “.csv” file.



Figure 8-22 Knife contour

- 1 **“Axial run-out”**: shows the axial runout determined by the measuring sensor
- 2 **“Contour deviation”**: shows the measured deviation
- 3 **“Knife contour”**: shows the original knife contour
- 4 **“Grinding wheel front”**: displays the start/end offsets of the contour in relation to the front grinding wheel
- 5 **“Grinding wheel rear”**: displays the start/end offsets of the contour in relation to the rear grinding wheel
- 6 **“Serration unit”**: displays the start/end offsets of the contour in relation to the serration unit
- 7 **“Polishing unit”**: displays the start/end offsets of the contour in relation to the polishing unit
- 8 **“Back”**: switch to the previous display

8. Control

8.8.1 Axial run-out

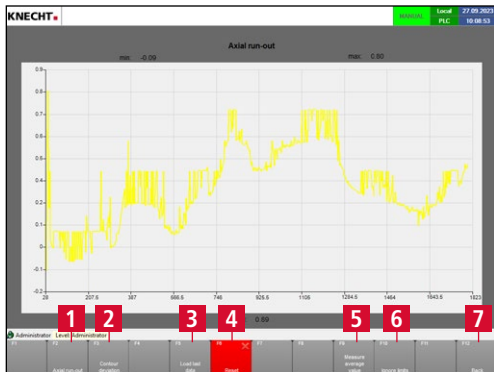

Figure 8-23 Knife contour "Axial run-out"

- 1 "Axial run-out"
- 2 "Contour deviation"
- 3 "Load last data"
- 4 "Reset": With Reset, the determined axial runout can be reset. At the next start of the serration, the axial runout is determined again if the axial runout measurement is activated. Otherwise, the determined axial runout is used until a new product file is loaded.
- 5 "Measure average value": Reduces the power output of the laser slightly so that the reflections are not too strong. The measurement peaks are smoothed slightly.
- 6 "Ignore limits"
- 7 "Back": switch to the previous display

8.8.2 Contour deviation

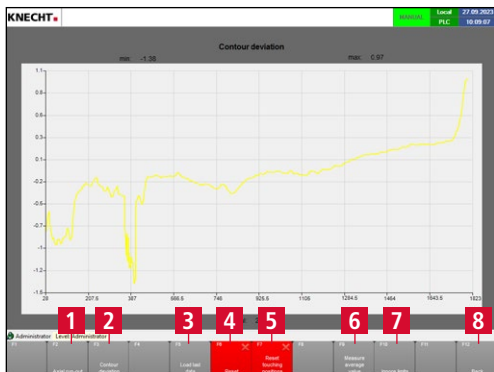

Figure 8-24 Knife contour "Contour deviation"

- 1 "Axial run-out"
- 2 "Contour deviation"
- 3 "Load last data"
- 4 "Reset"
- 5 "Reset touching positions": resets the probing position when current measurement is activated in the program
- 6 "Measure average value": Reduces the power output of the laser slightly so that the reflections are not too strong. The measurement peaks are smoothed slightly.
- 7 "Ignore limits"
- 8 "Back": switch to the previous display

8. Control

8.9 Knife selection

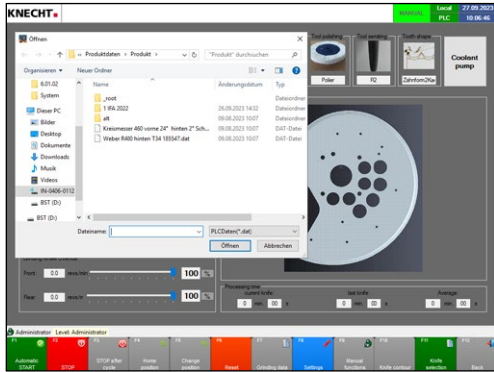

Figure 8-25 Knife selection

In the main menu under “Knife selection” (3-11/17) the “Open” dialog box (8-25) from Windows appears. The folder “C:\Product Data” is automatically displayed. The grinding programs for the individual knives are stored in this folder. The grinding programs have the file extension “.dat” .

Proceed as follows to load a grinding program: Select the desired grinding program. The name of the selected grinding program appears in the File name column. Click on the “Open” button to load the grinding program.

The “Open” dialog box closes and the selected grinding program is displayed in the main menu.

8. Control

8.10 Setting up an internet connection



Figure 8-26 Network port

The machine is equipped with an ethernet port. A secure connection between the machine and KNECHT Maschinenbau GmbH can be established via the integrated VPN router. The connection can be activated or deactivated by the operator using the key switch on the control cabinet (8-26/1).

This connection gives the KNECHT service technician access to the control and allows him to diagnose the machine, change the software settings and upload or edit new grinding programs.

There must be an active Internet connection to initiate the connection.

NOTE

When commissioning, the VPN router is configured according to the specified IT infrastructure so that the machine communicates exclusively with KNECHT Maschinenbau GmbH via the VPN server. Any communication within the customer network is excluded. The customer network is therefore optimally protected.

In order to establish the internet connection, plug the supplied ethernet cable into the on-site network socket (RJ45) and the network port on the control cabinet of the grinding machine.

9. Care and maintenance



For all work on the grinding machine, observe the locally applicable safety and accident prevention regulations as well as instructions in the "Safety" and "Important notes" section of the operating instructions.

9.1 Coolant

The coolant must be exchanged weekly and the water tray cleaned.

The water tray must always be filled with water up to 5 cm below the edge. For filling and cleaning, the water tray can be pulled out to the front.

9.1.1 Coolant additive

No coolant additive may be added to the cooling water.

ATTENTION

The laser must not come into contact with oily mist. Therefore, no coolant additive may be used.

9.2 Cleaning

The machine must be cleaned after each grinding operation, otherwise the grinding abrasion dries and is difficult to remove.

For pre-cleaning, we recommend a commercially available wet vacuum cleaner. For final cleaning we recommend soft cleaning cloths.

Clean the windows with soft cleaning cloths and window cleaning agent.

After cleaning the grinding machine, we recommend using the products listed in the Cleaning agent and lubricant table for care of the machine (see Chapter 9.2.1).

ATTENTION

The grinding machine must not be sprayed with water. Machine components may be damaged or destroyed.

9. Care and maintenance

9.2.1 Cleaning agent and lubricant table

Cleaning / Lubrication work	Interflon	WÜRTH	SHELL	EXXON Mobil	OEST
Cleaning and care of machine parts	Dry Clean Stainless Steel	Stainless steel care spray	Risella 917	Marcol 82	New Process Multispray
Lubrication of threads and sliding surfaces	Fin Grease	Multi-purpose grease	Gadus S2 V1002	Mobilith SHC 100	Multi-purpose grease LT 190 EP
Lubrication nipples	Grease MP 100		Gadus S5 V142 W0018		IXELON LT 000 EP
Lubrication nipples polishing gearbox		Multi-purpose grease	Gadus S2 V1002	Mobilith SHC 100	Multi-purpose grease LT 190 EP

9.3 Maintenance plan (one-shift operation)

Interval	Assembly	Maintenance task
Daily	All machine surfaces	Clean with soft cleaning cloth and care spray.
	Slide angle adjustment	Clean angle adjustment with brush and cleaning cloth and oil.
Weekly	Star handle threads	Lubricate with multi-purpose grease.
	Water tray	Replace coolant and clean water tray.
	Slide angle adjustment	Lubricate lubrication nipple with grease (see Chapter 9.4.2).
		Clean and oil steel shafts.
Monthly	Serration unit	Clean the optical sensor glass with cleaning cloth.
	Slide grinding wheels	Lubricate lubrication nipple with grease (see Chapter 9.4.1).
	Axes	Lubricate lubrication nipple with grease (see Chapter 9.4.5).
	Safety doors	Lubricate the guides of the safety doors.
	Slide serration unit	Lubricate lubrication nipple with grease (see Chapter 9.4.3).
	Polishing unit	Lubricate lubrication nipple with grease (see Chapter 9.4.4).
Semi-annually	Coolant system	Remove and clean the flow monitor.
	Polishing unit	Clean and oil guide rods.
Annually		Contact the service department of KNECHT Maschinenbau GmbH

9. Care and maintenance

9.4 Lubrication points

9.4.1 Lubricating the grinding wheel slide

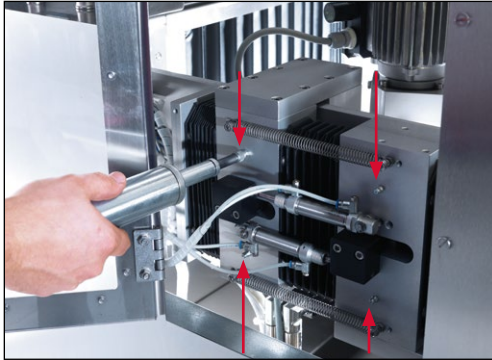

Figure 9-1 Lubricating the grinding wheel slide

To lubricate the slide unit, the maintenance door on the left side of the machine must be opened.

Apply the grease press to the four lubrication nipples (9-1) and lubricate the slide.

We recommend "OEST IXELON LT 000 EP" or a corresponding commercial fluid grease.

Once a month, press one stroke of grease into the lubrication nipples using the grease press.

9.4.2 Lubricating the angle adjustment slide

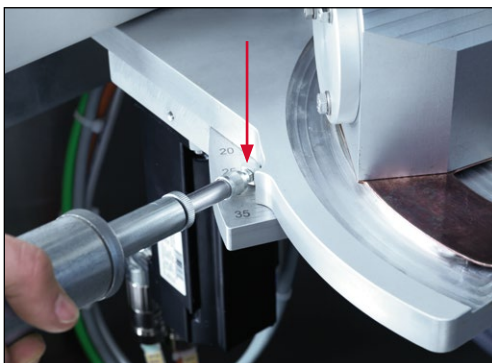

Figure 9-2 Lubricating the front of the angle adjustment slide

To lubricate the slides, the safety doors of the machine must be opened.

Apply the grease press to the two lubrication nipples at the front (9-2) and lubricate the slide.

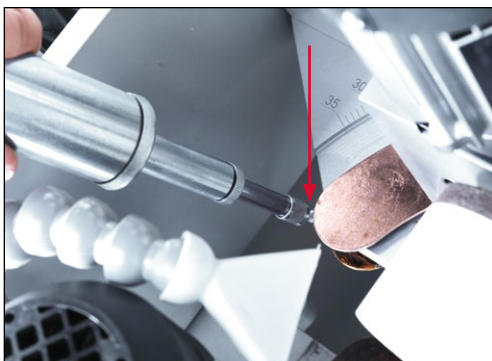

Figure 9-3 Lubricating the rear of the angle adjustment slide

Apply grease press to the two lubrication nipples at the rear (9-3) and lubricate the slide.

We recommend "OEST IXELON LT 000 EP" or a corresponding commercial fluid grease.

Press one stroke of grease into the lubrication nipples weekly using the grease press.

9. Care and maintenance

9.4.3 Lubricating the serration unit (optional)

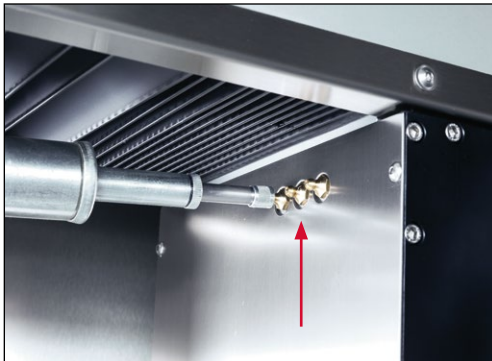

Figure 9-4 Lubricating the top of the serration unit

To lubricate the serration unit, the safety doors of the machine must be opened.

Apply the grease press to the three lubrication nipples at the top (9-4) and lubricate the serration unit.

We recommend "OEST IXELON LT 000 EP" or a corresponding commercial fluid grease.

Once a month, press one stroke of grease into the lubrication nipples using the grease press.

9.4.4 Lubricating the polishing unit (optional)

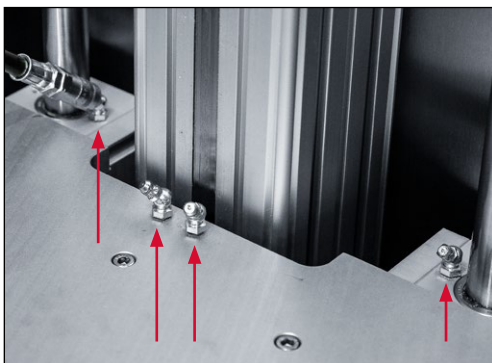

Figure 9-5 Lubricating the upper polishing unit (rear/front guides and cross adjustment)

To lubricate the polishing unit, the safety doors of the machine must be opened.

Apply the grease press to the four lubrication nipples (9-5) and lubricate the polishing unit.

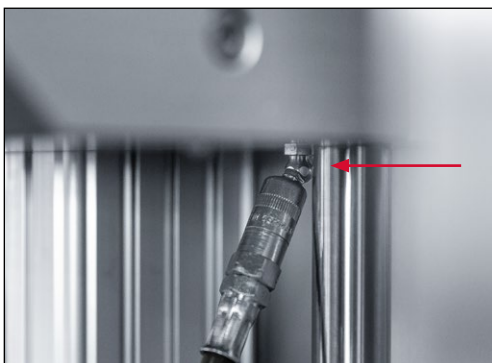

Figure 9-6 Lubricating the lower polishing unit (front guide)

Apply the grease press to the lower lubrication nipple (9-6) of the front guide and lubricate the polishing unit.

We recommend "OEST IXELON LT 000 EP" or a corresponding commercial fluid grease.

Once a month, press a stroke of grease into the lubrication nipples using the grease press.

9. Care and maintenance

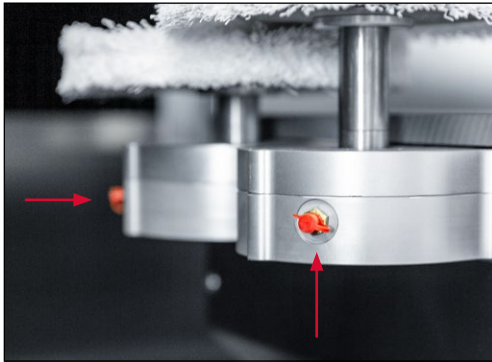

Figure 9-7 Lubricating the polishing gearbox

The lubrication nipples of the polishing gearbox are fitted with red protective caps. They are lubricated by KNECHT Service at the maintenance interval.

The polishing gearbox may only be lubricated by the user after consultation with KNECHT Maschinenbau GmbH.

Once a year or if the polishing unit generates increased noise, press three strokes of grease into the lubrication nipples using the grease press.

We recommend "OEST multi-purpose grease LT 190 EP" or a corresponding commercially available multi-purpose grease.

ATTENTION

Lubrication nipples with red protective caps are lubricated by KNECHT Service.

Too much grease in the polishing gear leads to sluggishness of the polishing disks.

9.4.5 Lubricating the cross slide



Figure 9-8 Lubricating the top of the cross slide

To lubricate the slide, the safety doors of the machine must be opened.

Apply the grease press to the two lubrication nipples (9-8) and lubricate the top of the cross slide.

9. Care and maintenance

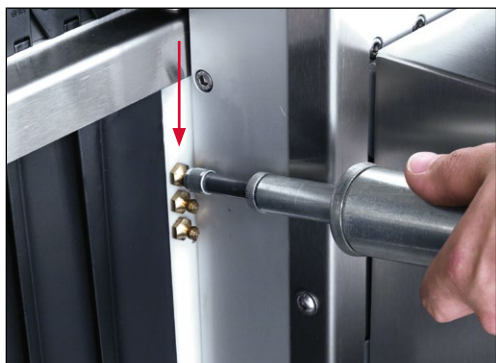

Figure 9-9 Lubricate the side of the cross slide

Apply the grease press to the three lubrication nipples (9-9) and lubricate the side of the cross slide.

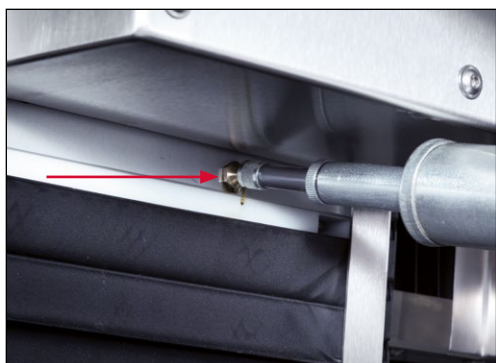

Figure 9-10 Lubricate the bottom of the cross slide

Apply grease press to the lubrication nipple (9-10) and lubricate the bottom of the cross slide.

We recommend "OEST IXELON LT 000 EP" or a corresponding commercial fluid grease.

Once a month, press a stroke of grease into the lubrication nipples using the grease press.

10. Disassembly and disposal

10.1 Disassembly

All operating materials must be disposed of properly.

Secure moving parts against slippage.

Disassembly must be conducted by a qualified specialist.

10.2 Disposal

After the machine has reached the end of its service life, it must be disposed of by a qualified specialist. In exceptional situations, and after consultation with KNECHT Maschinenbau GmbH, the machine may be returned.

Operating materials (e.g. grinding wheels, grinding belts, finned brushes, etc.) must be disposed of correctly.

11. Service, spare parts and accessories

11.1 Postal address

KNECHT Maschinenbau GmbH
Witschwender Straße 26
88368 Bergatreute
Germany

Phone +49-7527-928-0
Fax +49-7527-928-32

mail@knecht.eu
www.knecht.eu

11.2 Service

Service line:

For address, see postal address

service@knecht.eu

11.3 Wear and spare parts

If you need spare parts, please use the spare parts list provided with the machine. Please place your order using the format described below.

When ordering, please always provide: (example)

Machine type	(A95)
Machine number	(01105895)
Designation of assembly	(Z slide)
Designation of individual part	(Cam Plate Bearing Shaft G)
Item number (position number)	(9)
Drawing number (article number)	(2000095-15543)
Quantity	(1 pc)

We are always happy to answer any questions.

11. Service, spare parts and accessories

11.4 Accessories

11.4.1 Abrasives used etc.

Designation	Dimension	Grain	Article number	Note
Grinding wheel Si	d.100x60xd.40	K80	412B-87-0080	standard accessory for heavy material removal
Grinding wheel Si	d.100x60xd.40	K120	412B-87-0120	for heavy material removal
Grinding wheel Si	d.100x60xd.40	K240	412B-87-0240	standard accessory to remove teflon coating
Grinding wheel EK	d.100x60xd.40	K320	412B-80-0798	standard grinding
Grinding wheel EK	d.100x60xd.40	K800	412B-80-0800-25	standard accessory for deburring
CBN grinding wheel 15/10	d.100x60x40	B46	412F-73-1510-46	installed on delivery
CBN grinding wheel 15/10	d.100x60x40	B126	412F-73-1510-126	slightly coarser than B46
CBN grinding wheel 15/10	d.100x60x40	B252	412F-73-1510-252	for heavy material removal
CBN grinding wheel 6/10	d.100x43x40	B46	412F-73-0610-46	for hard knife steel
Dressing diamond 1,5 carat DK10	d.10x21		312A-01-8802	included in scope of delivery
Intermediate flange for ceramic grinding wheel with clamping screw	d.60x25		2000060-8039	included in scope of delivery
Dressing stone C	20x20x150		412P-03-0471	included in scope of delivery
Dressing stone C with handle	35/25x16x225		412P-01-0499	included in scope of delivery

11.4.2 Abrasives used etc. for serration unit and polishing unit

Designation	Dimension	Grain	Article number	Note
CBN profiling wheel H7 R2	d.200x5xd.17		412F-60-0240	installed on delivery
HT round brush Type B5	d.200x20xd.17		412N-07-0200	installed on delivery

ATTENTION

Only original abrasives, wear and spare parts from KNECHT Maschinenbau GmbH are permitted to be used.

11. Service, spare parts and accessories

ATTENTION

KNECHT Maschinenbau GmbH assumes no responsibility for the use of non-original parts.

If you require abrasives or other accessories, please contact our sales staff and distributors, or KNECHT Maschinenbau GmbH directly.

Thank you for choosing KNECHT!

12. Appendix

12.1 EU Declaration of Conformity

in accordance with EU Directive 2006/42/EU

- Machinery 2006/42/EU
- Electromagnetic Compatibility 2014/30/EU

We hereby declare that the machine designated as follows, due to its construction and design, as well as the version we placed on the market, complies with the relevant fundamental safety and health requirements of the applicable EU Directive.

In case of a modification of the machine not agreed with us, this declaration loses its validity.

Machine designation:	Grinding Machine for Sickle-shaped and Circular Knives
Model designation:	A 95
Machine number:	from no. 22057095
Applicable harmonized standards, in particular:	DIN EN ISO 12100-1 DIN EN ISO 12100-2 DIN EN 60204-1 ISO 13857 DIN EN 349
Responsible for documentation:	Peter Heine (B. Eng. Mechanical Engineering BA) Phone +49-7527-928-15 p.heine@knecht.eu
Manufacturer:	KNECHT Maschinenbau GmbH Witschwender Straße 26 88368 Bergatreute Germany

A complete technical documentation is available. The operating instructions document for the machine is available in its original version and in the native language of the user.

The validity of the declaration expires in the event of changes to the legal requirements.

Bergatreute, November 13, 2023

KNECHT Maschinenbau GmbH

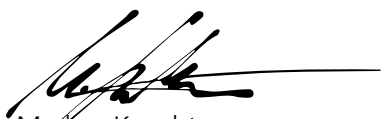
Markus Knecht
CEO

KNECHT Maschinenbau GmbH

Witschwender Straße 26 · 88368 Bergatreute · Germany · T +49-7527-928-0 · F +49-7527-928-32
mail@knecht.eu · www.knecht.eu