

## Operating Instructions

### A 950 III

Grinding Machine for Sickle-shaped and Circular Knives



# Operating Instructions

---

## A 950 III Grinding Machine for Sickle-shaped and Circular Knives

### Manufacturer

KNECHT Maschinenbau GmbH  
Witschwender Straße 26  
88368 Bergatreute  
Germany

Phone +49-7527-928-0  
Fax +49-7527-928-32

mail@knecht.eu  
www.knecht.eu

### Documents for machine operator

Operating Instructions

### Date of issue of the operating instructions

March 6, 2024

### Copyright

These operating instructions as well as the operating documents remain the copyright property of KNECHT Maschinenbau GmbH. They are supplied only to customers and operators of our products and belong to the machine.

Without our express permission, these documents may neither be duplicated nor made accessible to third parties, in particular competitor companies.

# Table of Contents

---

<b>1.</b>	<b>Important notes</b>	<b>7</b>
<b>1.1</b>	<b>Preface to the operating instructions</b>	<b>7</b>
<b>1.2</b>	<b>Warnings and symbols in the operating instructions</b>	<b>7</b>
<b>1.3</b>	<b>Warning and mandatory signs and their meaning</b>	<b>8</b>
1.3.1	Warning and mandatory signs on/in the grinding machine	8
1.3.2	General mandatory signs	8
<b>1.4</b>	<b>Rating plate and machine serial number</b>	<b>9</b>
<b>1.5</b>	<b>Figure and position numbers in the operating instructions</b>	<b>10</b>
<b>2.</b>	<b>Safety</b>	<b>11</b>
<b>2.1</b>	<b>Basic safety instructions</b>	<b>11</b>
2.1.1	Observe notes in the operating instructions	11
2.1.2	Obligation on the part of the operator	11
2.1.3	Obligation on the part of the personnel	11
2.1.4	Hazards involved in handling the grinding machine	11
2.1.5	Malfunctions	12
<b>2.2</b>	<b>Intended use</b>	<b>12</b>
<b>2.3</b>	<b>Warranty and liability</b>	<b>12</b>
<b>2.4</b>	<b>Safety regulations</b>	<b>13</b>
2.4.1	Organizational measures	13
2.4.2	Protective equipment	13
2.4.3	Informal safety measures	13
2.4.4	Selection and qualification of personnel	13
2.4.5	Machine control system	14
2.4.6	Safety measures in normal operation	14
2.4.7	Hazards due to electrical power sources	14
2.4.8	Particular hazard areas	14
2.4.9	Servicing (maintenance, repair) and fault rectification	15
2.4.10	Structural alterations to the grinding machine	15
2.4.11	Cleaning the grinding machine	15
2.4.12	Lubricants /oils and greases	15
2.4.13	Relocation of the grinding machine	15
<b>3.</b>	<b>Description</b>	<b>17</b>
<b>3.1</b>	<b>Intended use</b>	<b>17</b>
<b>3.2</b>	<b>Technical specifications</b>	<b>17</b>
<b>3.3</b>	<b>Functional description</b>	<b>18</b>
<b>3.4</b>	<b>Description of the assemblies</b>	<b>19</b>
3.4.1	Switching the grinding machine on/off	21
3.4.2	Control panel	22
3.4.3	Layout of user interface (main screen)	23

# Table of Contents

---

<b>4.</b>	<b>Transport</b>	<b>24</b>
4.1	Transport aids	24
4.2	Transport damage	24
4.3	Transport to another installation site	24
<b>5.</b>	<b>Installation</b>	<b>25</b>
5.1	Selection of qualified personnel	25
5.2	Installation site	25
5.3	Supply connections	25
5.4	Settings	25
5.5	Initial start-up of the grinding machine	26
<b>6.</b>	<b>Commissioning</b>	<b>27</b>
<b>7.</b>	<b>Operation</b>	<b>29</b>
7.1	Switch on the grinding machine	29
7.2	Grind knives	29
7.2.1	Load grinding program	29
7.2.2	Mount cam disc SP116	30
7.2.3	Grind the slicer knife without suspension attachment	33
7.2.4	Grinding the slicer knife with suspension attachment	35
7.2.5	Grind circular knives	37
7.2.6	Set the knife at the center of the disc	39
7.3	Dressing the front/rear ceramic grinding wheels	40
7.4	Changing the front/rear grinding wheels	42
7.4.1	Intermediate flange for ceramic grinding wheels	43
7.5	Adjusting the grinding angle	44
<b>8.</b>	<b>Control</b>	<b>45</b>
8.1	Main screen	45
8.2	Grinding program	46
8.3	Grinding data	47
8.3.1	Data	48
8.3.2	Abrasives	48
8.3.3	Steps	48
8.4	Settings	50
8.5	Axes manual mode	51
8.6	Manual functions	52
8.6.1	General	52

# Table of Contents

---

8.6.2	Grinding wheel front	53
8.6.3	Rear grinding wheel	53
8.6.4	Knife holder	53
<b>8.7</b>	<b>Machine data</b>	<b>55</b>
8.7.1	General	55
8.7.2	Options	56
8.7.3	Support	56
8.7.4	Tools – Grinding wheel front/rear	56
<b>8.8</b>	<b>Message texts</b>	<b>57</b>
<b>8.9</b>	<b>Options</b>	<b>58</b>
<b>8.10</b>	<b>Language</b>	<b>59</b>
<b>8.11</b>	<b>Setting up an internet connection</b>	<b>60</b>
<b>9.</b>	<b>Care and maintenance</b>	<b>61</b>
<hr/>		
<b>9.1</b>	<b>Coolant</b>	<b>61</b>
<b>9.2</b>	<b>Clean the grinding machine</b>	<b>61</b>
9.2.1	Cleaning agent and lubricant table	62
<b>9.3</b>	<b>Maintenance plan (one-shift operation)</b>	<b>62</b>
<b>9.4</b>	<b>Lubrication points</b>	<b>63</b>
9.4.1	Lubricating the cross slide	63
9.4.2	Lubricating the grinding wheel slide	63
<b>10.</b>	<b>Disassembly and disposal</b>	<b>64</b>
<hr/>		
<b>10.1</b>	<b>Disassembly</b>	<b>64</b>
<b>10.2</b>	<b>Disposal</b>	<b>64</b>
<b>11.</b>	<b>Service, spare parts and accessories</b>	<b>65</b>
<hr/>		
<b>11.1</b>	<b>Postal address</b>	<b>65</b>
<b>11.2</b>	<b>Service</b>	<b>65</b>
<b>11.3</b>	<b>Wear and spare parts</b>	<b>65</b>
<b>11.4</b>	<b>Accessories</b>	<b>66</b>
11.4.1	Abrasives used etc.	66
<b>12.</b>	<b>Appendix</b>	<b>67</b>
<hr/>		
<b>12.1</b>	<b>EU Declaration of Conformity</b>	<b>67</b>

# 1. Important notes

---

## 1.1 Preface to the operating instructions

These operating instructions are intended to make it easy to learn how to use the grinding machine for sickle-shaped and circular knives, hereafter referred to as the grinding machine, and to properly utilize its features.

The operating instructions contain important information on how to operate the grinding machine safely, properly and cost-effectively. Observing these instructions helps to avoid hazards, reduce repair costs and downtimes, and to increase the reliability and service life of the grinding machine.

The operating instructions must always be accessible at the place of use of the grinding machine.

The operating instructions must be read and used by all persons entrusted with working on the grinding machine, e.g.:

- transport, installation, commissioning
- operation, including fault elimination in the process flow
- upkeep (maintenance, repair).

In addition to the operating instructions and the binding accident prevention regulations applicable in the country and place of use of the machine, the generally acknowledged rules of technology with regard to safe and professional work practices are to be observed.

## 1.2 Warnings and symbols in the operating instructions

The operating instructions use the following symbols/designations that must be followed:



The hazard triangle with the signal word "CAUTION" serves as a work safety notice for all work for which there is a risk of personal injury or death.

In these cases, work should be done with special attention and care.



"ATTENTION" is written in places where special attention must be paid to prevent damage or destruction of the grinding machine or its surroundings.



"NOTICE" refers to user tips and especially useful informations.

# 1. Important notes

---

## 1.3 Warning and mandatory signs and their meaning

### 1.3.1 Warning and mandatory signs on/in the grinding machine

The following warnings and mandatory signs have been affixed on/in the grinding machine:



#### **CAUTION! DANGEROUS ELECTRICAL VOLTAGE (warning notice on the control panel)**

The grinding machine carries life-threatening voltage when it is connected to the power supply.

Voltage-carrying device parts may only be opened by authorized personnel.

The grinding machine must be separated from the mains supply before carrying out servicing, maintenance and repair work on it.



#### **CAUTION! RISK OF INJURY FROM KNIFE (mandatory sign on the base plate)**

Working with the grinding machine involves grinding knives that could cause serious cut injuries due to their sharpness.

Protective gloves must be worn when clamping and releasing knives.

Caution when transporting knives! Use the protective equipment provided by the knife manufacturer. Protective gloves and safety shoes must be worn.

### 1.3.2 General mandatory signs

The following general mandatory signs must be followed:



#### **CAUTION! RISK OF INJURY DUE FROM ABRASIVE PARTICLES DURING DRESSING**

Dressing the grinding wheels gives rise to grinding particles that could enter the eyes.

Wearing eye protection is mandatory when carrying out such work.

# 1. Important notes

---

## 1.4 Rating plate and machine serial number



Figure 1-1 Rating plate

The rating plate (1-1) is located on the right side of the machine behind the switch cabinet.

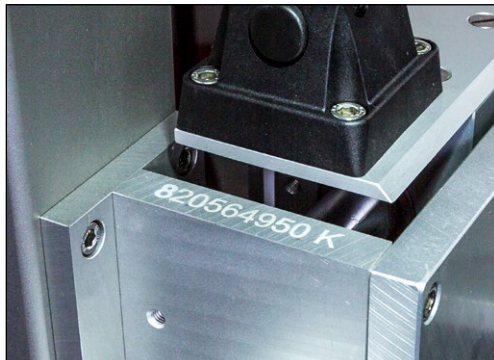

Figure 1-2 Machine number

The machine serial number (1-2) is located on the rating plate (1-1) and at the front left at the machine.



# 1. Important notes

---

## 1.5 Figure and position numbers in the operating instructions

If the text makes a reference to a machine component depicted in a figure, the figure and position number will be given in brackets.

Example: (7-25/1) means picture number 7-25, position 1.

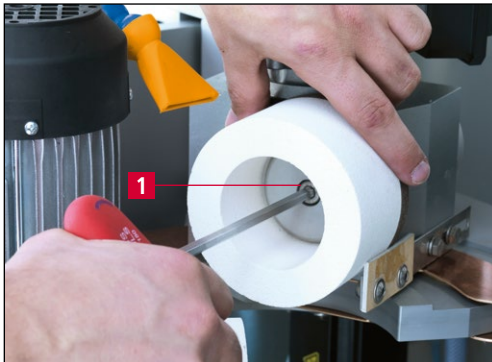

*With a hexagon screwdriver AF6 mm, loosen the screw in the center of the grinding wheel (7-25/1) counterclockwise and remove it.*

*Remove the front or rear grinding wheel and also the connection flange (7-26/1) if necessary and mount the new grinding wheel in the reverse order.*

**Figure 7-25** Changing the grinding wheels

## 2. Safety

---

### 2.1 Basic safety instructions

#### 2.1.1 Observe notes in the operating instructions

The basic prerequisite for the safe handling and uninterrupted operation of this grinding machine is knowledge of the basic safety instructions and regulations.

- These operating instructions contain important notes on how to operate the grinding machine safely.
- All persons carrying out work on the grinding machine must follow these operating instructions, in particular the safety notices.
- In addition, the rules and regulations regarding accident prevention at the place of use are to be observed.

#### 2.1.2 Obligation on the part of the operator

The operator is obliged to allow only those persons to work on the grinding machine, who

- are familiar with the occupational safety and accident prevention regulations and have received instruction in handling the grinding machine,
- have read and understood the operating instructions, in particular the section entitled "Safety" and the warning notes, and have provided signed confirmation of this.

The safety-awareness of the personnel at work will be monitored at regular intervals.

#### 2.1.3 Obligation on the part of the personnel

All personnel working on the grinding machine shall be obliged, before starting work, to

- observe basic occupational safety and accident prevention regulations,
- read the operating instructions, particularly the section entitled "Safety" and the warning notes, and provide signed confirmation that they have understood them.

#### 2.1.4 Hazards involved in handling the grinding machine

The grinding machine has been built to the latest technological standards and the recognized rules of technical safety. In spite of this, its use poses inherent risks which could result in bodily harm or even death of the user or third persons, or damage to the grinding machine or other property. The grinding machine may be used only:

- for its intended purpose
- in a safe and secure condition.

Malfunctions that may impair safety are to be eliminated immediately.

## 2. Safety

---

### 2.1.5 Malfunctions

If safety-relevant malfunctions occur with the grinding machine, or if the processing behavior indicates that such malfunctions may have occurred, the grinding machine must be stopped immediately and until such time as the malfunction has been found and eliminated.

Allow only authorized trained personnel to eliminate the malfunctions.

## 2.2 Intended use

The grinding machine is only designed for grinding slicer knives. Before starting work on a slicer knife, a check must first be carried out as to whether the slicer knife fits onto the cam disc. Only then may the slicer knife be clamped onto the cam disc.

Any other use or use beyond this is not considered as intended. KNECHT Maschinenbau GmbH is not liable for any damage resulting from this. The risk is borne solely by the user.

Intended use also includes observing all instructions in the operating manual.

### **ATTENTION**

**The grinding machine is being used improperly if, for example:**

- **The slicer knife is sharpened without the cam disc.**
- **Fixtures are not properly attached.**

## 2.3 Warranty and liability

Warranty and liability claims in case of personal injury or property damage are excluded if such damage is attributable to one or more of the following causes:

- improper use of the grinding machine,
- improper transport, commissioning, operation, and maintenance of the grinding machine,
- operating the grinding machine with defective safety devices, or using improperly attached or malfunctioning safety and protective equipment,
- failure to observe the instructions with regard to transportation, commissioning, operation, maintenance and repair of the grinding machine,
- unauthorized structural alterations to the grinding machine,
- unauthorized modification, e.g. of the drive conditions (output and speed),
- failure to monitor machine parts that are subject to wear, and

## 2. Safety

---

- use of unapproved replacement and wear parts.

Use only original replacement and wear parts. If externally purchased parts are used, it is not guaranteed that they have been designed and manufactured to meet the requirements in terms of stress and safety.

### 2.4 Safety regulations

#### 2.4.1 Organizational measures

Inspect all available safety devices regularly.

Observe prescribed intervals for recurring maintenance work or as specified in the operating instructions!

#### 2.4.2 Protective equipment

Before every commissioning of the grinding machine, ensure that all protective equipment is properly mounted and in functional condition.

Protective equipment may be removed only after the grinding machine has stopped and has been secured against accidental restart.

When attaching spare parts, the protective equipment must be attached by the operator as stipulated.

#### 2.4.3 Informal safety measures

The operating instructions must be permanently available at the place of use of the grinding machine. In addition to the operating instructions, the generally applicable as well as locally relevant accident prevention regulations must also be made available and observed.

All safety alert symbols and hazard warnings on the grinding machine must be complete and clearly legible.

#### 2.4.4 Selection and qualification of personnel

Only trained and instructed personnel may work on the grinding machine. Observe the legally permitted minimum age!

The responsibilities of personnel with respect to commissioning, operation, maintenance, and repair must be clearly specified.

Personnel still undergoing training or instruction may only work on the grinding machine under the permanent supervision of an experienced person!

## 2. Safety

---

### 2.4.5 Machine control system

Do not make any changes to the software program under any circumstances. Parameters that the operator can set himself are excluded from this (e.g. setting the number of cycles).

Only trained and instructed personnel are permitted to switch on and operate the machine.

### 2.4.6 Safety measures in normal operation

Do not operate the machine in any unsafe manner. Only operate the grinding machine if all the safety devices are installed and fully functional.

At least once per shift (or per day), check the grinding machine for externally visible damage and proper functioning of the safety devices.

Immediately report any changes present (including those of the operating behavior) to the responsible office or person. If necessary, immediately shut down the grinding machine and secure it against restart.

Before you switch on the grinding machine, ensure that no one can be injured by the start-up of the machine.

In the event of a malfunction, immediately stop the grinding machine and secure it against restart. Rectify malfunctions immediately.

### 2.4.7 Hazards due to electrical power sources

The switch cabinet must always remain secured against access. Only authorized personnel must be allowed to access it.

Work on electrical systems or operating materials may only be performed by a qualified electrician, in accordance with electrical regulations.

Defects, such as damaged cables, cable connections etc. must be immediately rectified by an authorized specialist.



**The yellow power supply cable is electrically live even when the main switch is turned off.**

### 2.4.8 Particular hazard areas

In the area of the grinding wheels, there is a danger of pinching and being drawn in (e.g. clothing, fingers and hair). Suitable personal protective equipment must be worn.

## 2. Safety

---

### 2.4.9 Servicing (maintenance, repair) and fault rectification

Maintenance work is to be carried out on schedule by trained personnel. Inform operating personnel before beginning repair work. Designate a supervisor responsible for this.

For all service work, the grinding machine is to be disconnected from the current supply and secured against accidental restart. Remove power plug. Secure repair area as necessary.

After completing maintenance work and fault rectification, install all safety devices and verify that they are fully functional.

### 2.4.10 Structural alterations to the grinding machine

Do not make any changes, additions or conversions to the grinding machine without the approval of the manufacturer. This also applies to the installation and setup of safety devices.

Any conversion work requires the written permission from KNECHT Maschinenbau GmbH.

Immediately replace machine parts that are not in perfect condition.

Use only original replacement and wear parts. If externally purchased parts are used, it is not guaranteed that they have been designed and manufactured to meet the requirements in terms of stress and safety.

### 2.4.11 Cleaning the grinding machine

Properly handle any cleaning agents and materials used and dispose of them in an environmentally-friendly manner.

Dispose of the wear parts and replacement parts in a safe and environmentally-friendly manner.

### 2.4.12 Lubricants /oils and greases

When using oils and greases, follow the safety regulations applicable to the product. Comply with the special regulations for the food areas.

### 2.4.13 Relocation of the grinding machine

Disconnect the grinding machine from any external power supply, even in the event of a minor change of location. Before restarting the grinding machine, connect it properly to the power supply.

For loading work, use only lifting equipment and load-bearing devices with sufficient lifting capacity. Appoint a qualified instructor for the lifting operation.

No persons other than those designated for this work may be present in the loading and installation area.

## 2. Safety

---

Only lift the grinding machine properly with lifting gear as specified in the operating instructions. Only use a suitable transport vehicle with sufficient load-bearing capacity. Secure the load reliably. Use suitable attachment points.

When restarting the machine, proceed only in accordance with the operating instructions.

# 3. Description

---

## 3.1 Intended use

The sickle and circular knife grinding machine A 950 III grinds slicer knives (sickle-shaped or circular) up to a maximum size of 900 mm. It is not suitable for grinding other types of knife such as hand knives.

## 3.2 Technical specifications

Height	1882 mm
Width	1669 mm
Depth	1043 mm
Space required (BxD)	3000 x 2800 mm
Weight	approx. 400 kg
Power supply*	3x 400 V
Mains frequency*	50 Hz
Power output*	0.5 kW
Power consumption*	1.9 kW
Current consumption*	4 A
Back-up fuse*	16 A
Control voltage*	+ 24 V DC
Compressed air according ISO 8573-1:2010 [1:4:2]	6 bar (50 l/min)
Measured A-evaluated emission sound pressure level at workstation LpA**	72 dB (A)
Speed of grinding wheels, front/rear	255 rpm
Grinding wheel A	d.100xd.40x60

\*) This information may change depending on the electrical power supply.

\*\*) Two-digit sound emission value according to EN ISO 4871 (measurement uncertainty KpA 3 dB (A)).

Emission sound pressure level according to EN ISO 11201. A slicer knife was ground (type known to KNECHT Maschinenbau GmbH).



### 3. Description

---

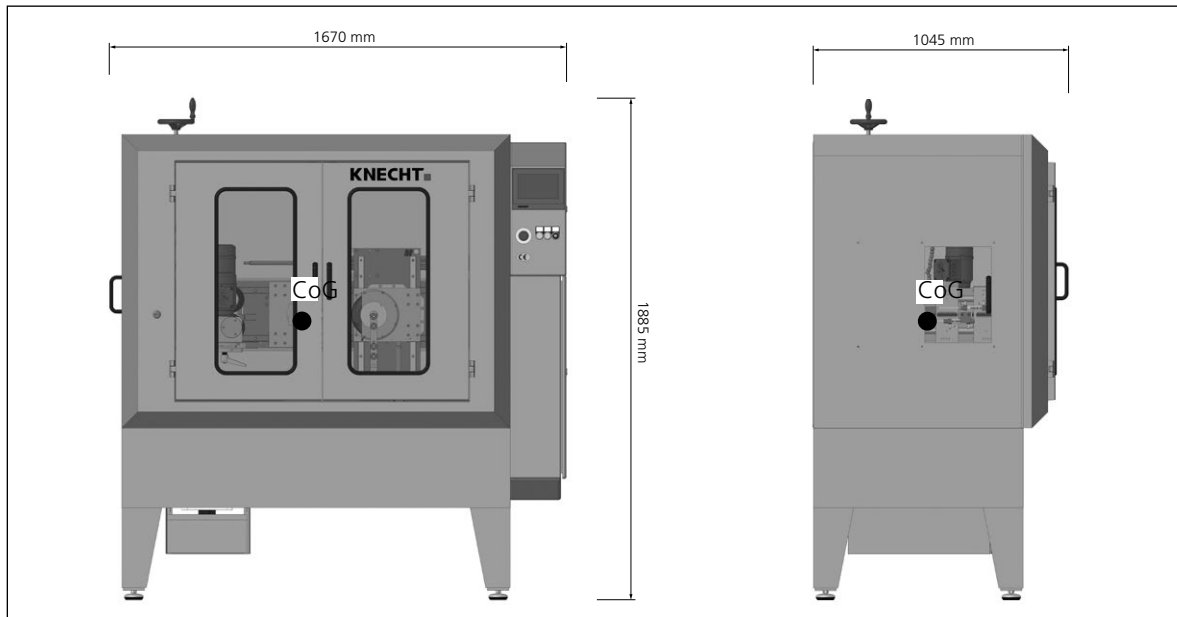

**Figure 3-1** Dimensions in mm and centers of gravity (CoG) of the machine

### 3.3 Functional description

The grinding machine can be used to automatically sharpen slicer knives (sickle-shaped or circular knives) with a size of maximum 900 mm.

The slicer knife is clamped onto a cam disc and sharpened along the knife edge by the grinding wheel precisely according to its shape.

In the event of an emergency, the grinding machine can immediately be stopped by pressing the "Emergency Stop" button

# 3. Description

## 3.4 Description of the assemblies

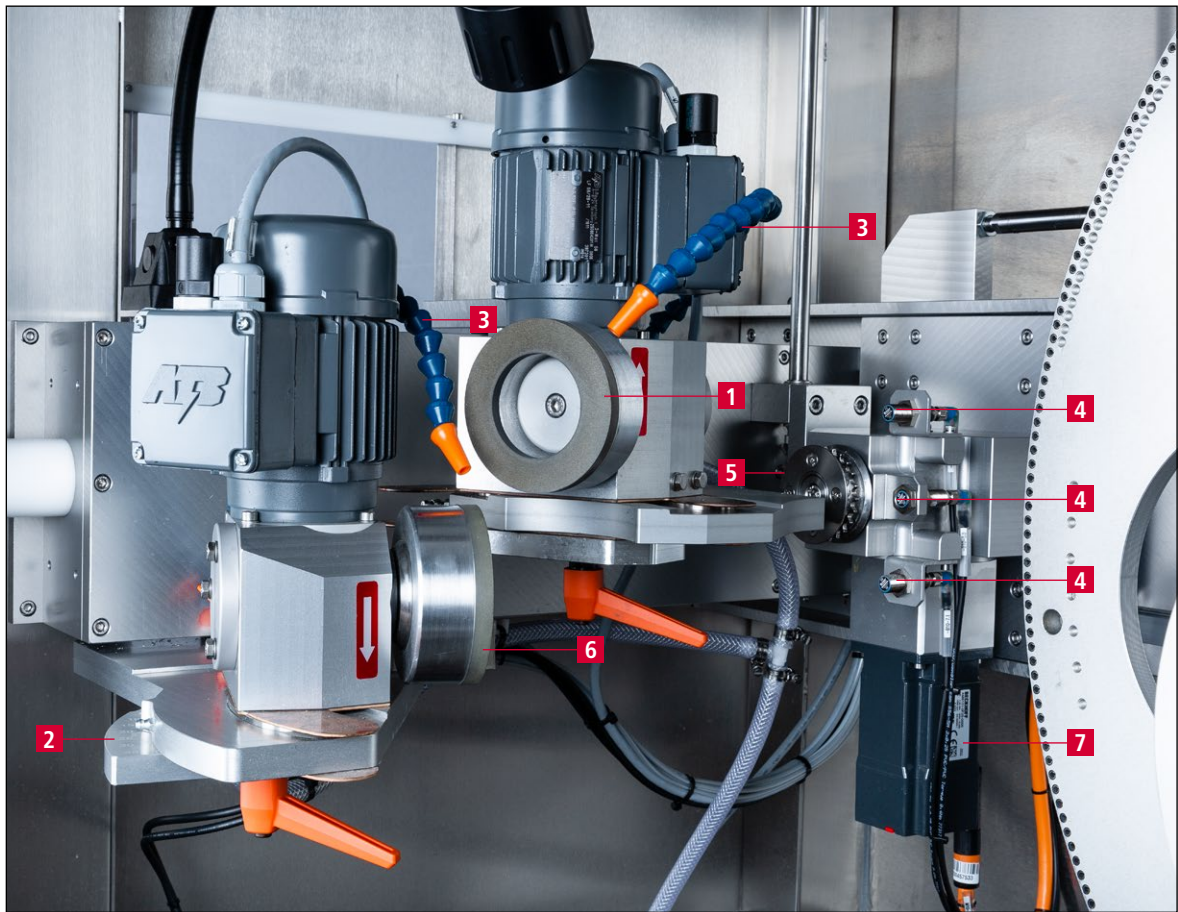

**Figure 3-2** General view of grinding machine

- 1 Hand wheel for grinding depth
- 2 Grinding unit
- 3 Water tray
- 4 Control unit with control panel
- 5 Cam disc SP 116 (with knife)
- 6 Machine feet

### 3. Description

---



**Figure 3-3** Grinding unit

- 1 Grinding wheel (rear)
- 2 Angle adjustment scale
- 3 Coolant hose
- 4 Inductive switch
- 5 Drive pinion of cam disc
- 6 Grinding wheel (front)
- 7 Cam disc drive (servo motor)

# 3. Description

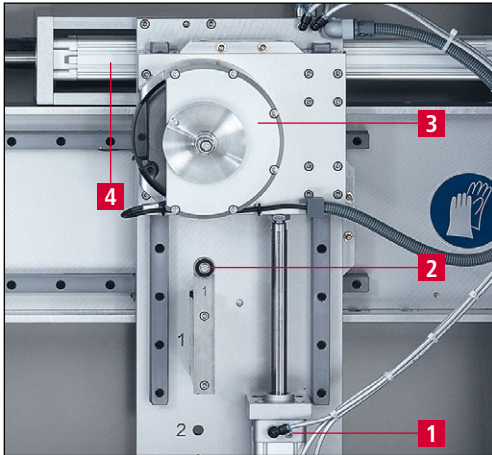

Figure 3-4 Cam disc bracket

- 1 Cylinder knife package up/down
- 2 Z coupling
- 3 Cam disc bracket
- 4 Cylinder for pressing on cam disc

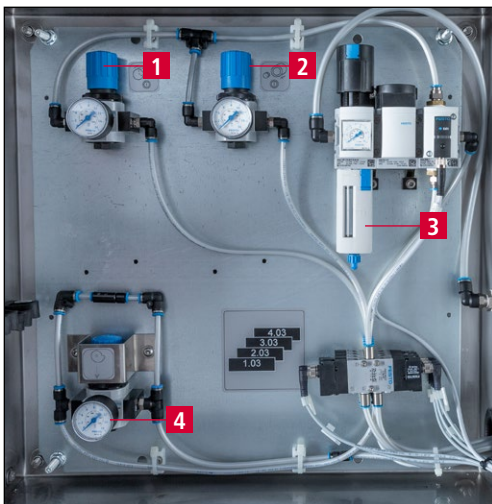

Figure 3-5 Pneumatic cabinet

- 1 Pressure on front grinding wheel
- 2 Pressure on rear grinding wheel
- 3 Maintenance unit
- 4 Cam disc pressure

## 3.4.1 Switching the grinding machine on/off



Figure 3-6 Main switch

- 1 Main switch

Turning the main switch to position "1 ON" the grinding machine is switched ready for operation.

Turning the main switch to position "0 OFF" the grinding machine is switched off.

# 3. Description

---

## 3.4.2 Control panel



- 1 Touch panel
- 2 "Emergency stop" button
- 3 "Control ON" button
- 4 "Start/Stop" button
- 5 "Setting operation" key switch: Position "1" for setting operation, Position "0" for automatic mode

Figure 3-7 Control panel

# 3. Description

## 3.4.3 Layout of user interface (main screen)

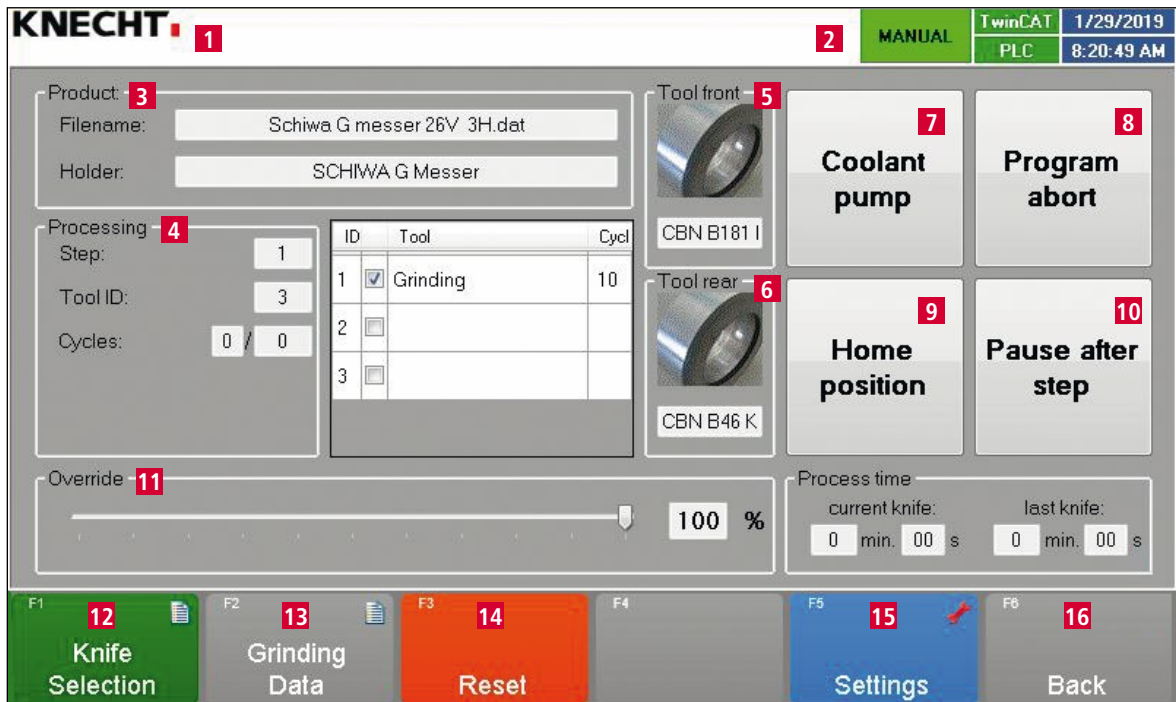

Figure 3-8 Main screen

- 1 Error messages
- 2 Status display
- 3 Product data (loaded grinding program)
- 4 Current processing step settings (stored in grinding program)
- 5 Front tool (front grinding wheel)
- 6 Rear tool (rear grinding wheel)
- 7 Coolant pump (switch coolant pump on/off)
- 8 Abort program (reset program after stop)
- 9 Home position (move grinding wheel to change position)
- 10 Break after step (program stops after current step)
- 11 Override (adapt speed to grinding disc)
- 12 **"F1 Knife Selection"**: select the desired grinding program, see Chapter 8.2
- 13 **"F2 Grinding Data"**: see Chapter 8.3
- 14 **"F3 Reset"**: delete current error
- 15 **"F5 Settings"**: see Chapter 8.4
- 16 **"F6 Back"**: return to previous screen

### NOTE

The assignment of the touch panel buttons varies according to the current display screen. The respective assignment is indicated in text form.

## 4. Transport

---



**When transporting, observe the local applicable safety and accident prevention regulations.**

**Only transport the grinding machine with the machine feet facing downwards.**

### 4.1 Transport aids

For transporting and for setting up of the grinding machine, only use adequately dimensioned transport aids. Remove the water tray before transporting.

When using a forklift or a lifting truck, move the fork under the grinding machine.

Note the machine's center of gravity when transporting. The center of gravity (CoG) is shown in Figure 3-1.

### 4.2 Transport damage

If damage is detected after unloading, during acceptance of the delivery, immediately inform KNECHT Maschinenbau GmbH and the forwarding agent. If necessary, an independent expert must be called in immediately.

Remove packaging and fastening straps. Remove the shipping straps on the grinding machine. Dispose of packaging in an environment-friendly manner.

### 4.3 Transport to another installation site

For transport to another installation site, ensure that the space requirements are fulfilled (see Chapter 3.2).

A permitted electrical connection, pneumatic connection and network connection must be available at the new installation site. The grinding machine must stand firmly and securely.



**Work on the electrical unit is only to be carried out by an authorized specialist. Observe the locally applicable safety and accident prevention regulations.**

# 5. Installation

---

## 5.1 Selection of qualified personnel



We recommend having maintenance work on the grinding machine carried out by trained KNECHT personnel.

We are not liable for any damage resulting from improper installation.

## 5.2 Installation site

When determining the installation site, bear in mind the space required for installation as well as maintenance and repair work on the grinding machine (see Chapter 3.2). The machine may only be stored or operated in dry rooms.

## 5.3 Supply connections

The grinding machine is delivered ready for connection with the appropriate connection cable.

The power supply must be installed on site by a qualified electrician.

The compressed air supply and the network connection must be installed on site by a qualified technician.



Only connect compressed air when the doors are closed.

Never remove compressed air when the knife is clamped.  
Serious injuries are possible.

Check that the power supply is connected correctly.

## 5.4 Settings

KNECHT Maschinenbau GmbH will configure the various components as well as the electrical system before delivery.

**ATTENTION**

Unauthorized alterations to the preset values are not permitted and can damage the grinding machine.



# 5. Installation

---

## 5.5 Initial start-up of the grinding machine

Place the grinding machine at the installation site on a level base.

Compensate uneven floors by turning the machine feet (3-2/6) with an AF 17 mm open-end wrench. Align the machine using a spirit level. To do this, place the spirit level on the guide rails of the grinding machine.

Dismantle all transport devices on the machine. Ensure that all axes (Figure 3-4) can move freely.

The power supply must be installed on site by a qualified electrician. The compressed air supply and the network connection must be installed on site by a qualified technician.

Completely install and inspect the protective equipment before commissioning.



**Have all protective equipment checked for proper functioning by authorized trained personnel before commissioning the machine.**

## 6. Commissioning



All work may only be carried out by authorized specialist personnel.

The applicable local safety and accident prevention regulations must be observed.

Only connect compressed air when the doors are closed.

Never remove compressed air when the knife is clamped.  
Serious injuries are possible.

Fill the water tray (3-2/3) to 3 cm below the rim with water.

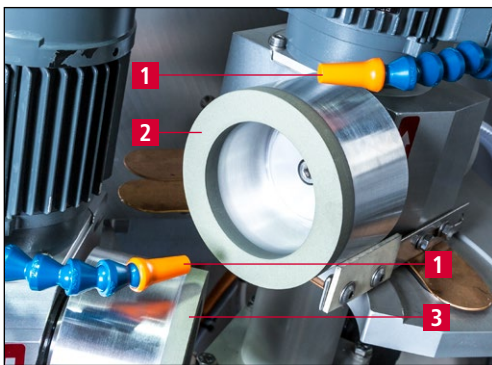

Figure 6-1 Setting the coolant hoses

Open the protective doors.

Set the coolant hoses (6-1/1) as shown. The gap from the rear grinding wheel (6-1/2) and the front grinding wheel (6-1/3) should be approx. 5 mm. The coolant hoses must not come into contact with the grinding wheels.

### ATTENTION

Maintain a minimum distance of 5 mm between the coolant hose and the grinding wheels, since the grinding wheels rotate during the grinding process.

Connect the power plug to the socket provided on site (3x 400 V, 16 A).

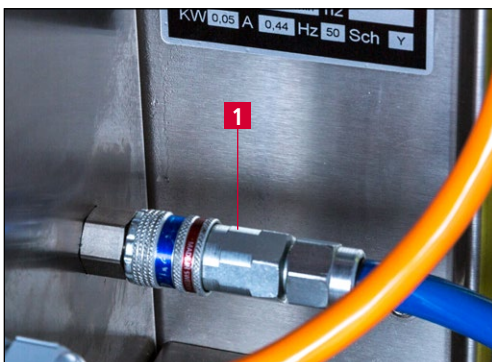

Figure 6-2 Compressed air connection

Connect the compressed air hose to the compressed air connection (6-2/1).

Close the protective doors.

# 6. Commissioning

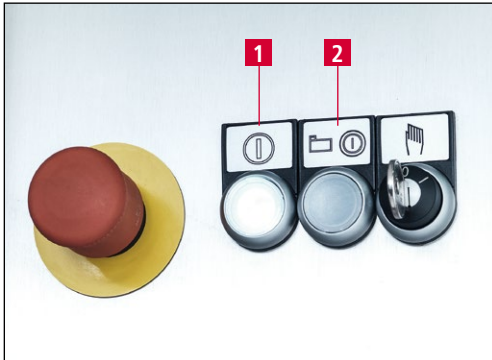

Figure 6-3 Control panel

Set the main switch (3-6/1) to position "I ON".  
Wait for the controls to initialize.

Switch on the control unit with the "Control ON" button (6-3/1) when the "Control ON" button (6-3/1) starts flashing.

**ATTENTION**

**Do not press the "START" button (6-3/2) under any circumstances.**

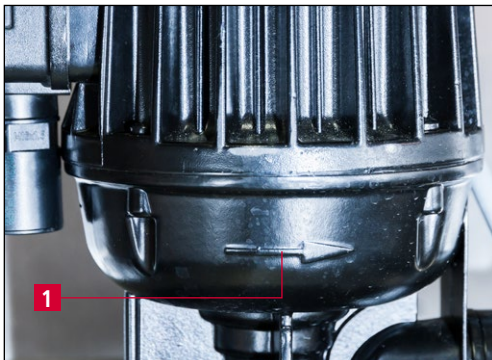

Figure 6-4 Check rotating direction

Check the direction of rotation of the coolant pump.

The direction arrow (6-4/1) indicates the direction of rotation of the pump.

If the rotating direction is incorrect, have the phase reversed by a qualified electrician.

**ATTENTION**

**Check that the power supply is connected correctly.**

**If the connection to the voltage supply is incorrect, the grinding belts and cam disc can rotate in reverse of the prescribed direction. An incorrect direction of rotation can result in serious damage.**

# 7. Operation



All work may only be carried out by authorized specialist personnel.

The applicable local safety and accident prevention regulations must be observed.

Never mount the knife without blade guard. Serious injuries are possible.

## 7.1 Switch on the grinding machine

Set the main switch (3-6/1) to position "I ON". Wait for the controls to initialize. The main screen (3-8) appears and the "Control ON" button (3-7/3) flashes.

Press the "Control ON" button (3-7/3), then turn key switch (3-7/5) to the position "0" (automatic mode).

## 7.2 Grind knives

### 7.2.1 Load grinding program



Figure 7-1 Main screen

Press the touch panel button "F1 Knife Selection" (7-1/1) on the main screen. The dialog box "Open" appears. The grinding programs are located in the "Product Data" folder.

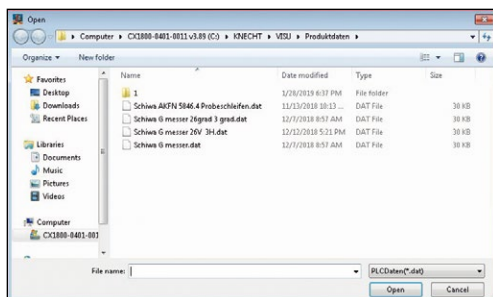

Figure 7-2 Loading a grinding program

Then select the desired grinding program by double clicking on the respective file. (Grinding programs have ".dat" in the file name).

The grinding program is now loaded and the "Open" dialog closes.

# 7. Operation

**ATTENTION**

Use the grinding program that matches the knife. An incorrect grinding program can damage the machine and knives.

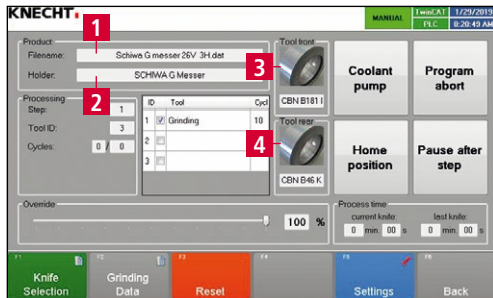

Figure 7-3 Main screen

The selected grinding program appears in the "File name" line (7-3/1) on the main screen.

Check the abrasives used (7-3/3) and (7-3/4) and change as necessary.

The images and data must match the abrasives used.

**NOTE**

The name of the cam disc matching the grinding program appears on the main screen under "Holder" (7-3/2). This name is engraved on the cam disc.

Each knife and each grinding program may require individual abrasives.

## 7.2.2 Mount cam disc SP 116



Figure 7-4 Mounting the Z coupling

Open the protective doors.

Mount the Z coupling on cam disc SP 116 as described and tighten using combination wrench SW 19 mm. Here, care should be taken to note the relevant marking on the Z coupling and the base plate.

# 7. Operation

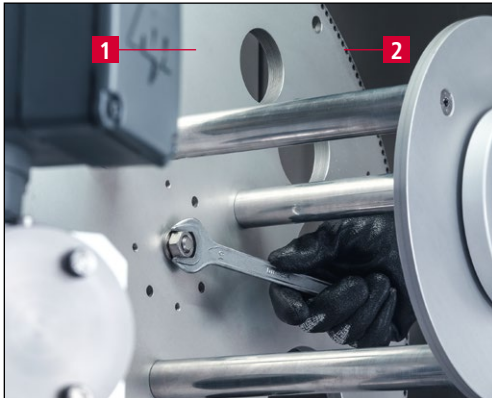

Figure 7-5 Mounting the cam disc SP 116

Insert cam disc SP 116 (7-5/1) in the bracket (3-4/3) and tighten with flat wrench SW 19 mm.

Hand tighten the cam disc in such a way that the boreholes (7-5/2) are oriented in the direction of the grinding wheels.

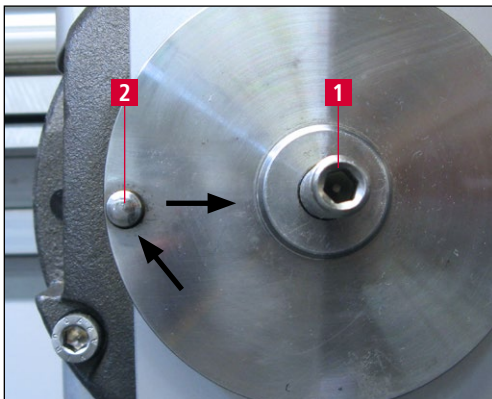

Figure 7-6 Spigot and centering pin

The spigot (7-6/1) and centering pin (7-6/2) must engage appropriately in the cam disc.

**ATTENTION**

**Incorrect positioning of cam disc SP 116 can damage the limit switches and the drive pinion.**

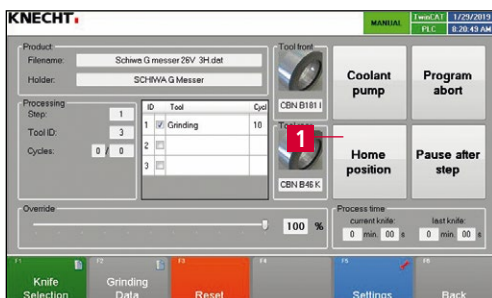

Figure 7-7 Move cam disc into change position

Close the protective doors.

Press "Home Position" (7-7/1) on the touch panel in the main menu to move the cam disc into the change position.

The cam disc moves to a position suitable for placing of knives.

## 7. Operation

---

### **ATTENTION**

Depending on the size and dimension of the knife, the knife can be unwieldy with a blade guard → Ergonomics.

Do not step inside the machine room in order to insert the knife.

# 7. Operation

## 7.2.3 Grind the slicer knife without suspension attachment

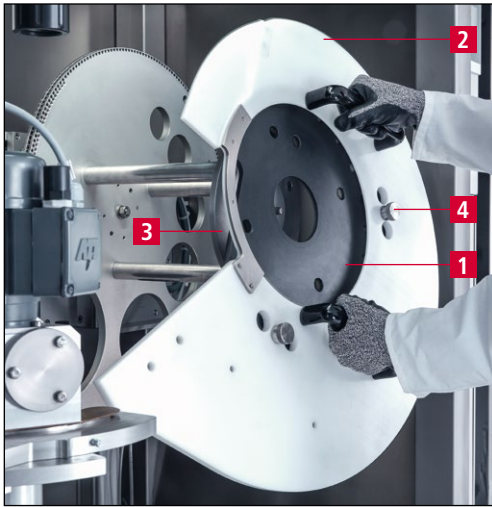

Figure 7-8 Place the knife

Open the protective doors.

Place the knife (7-8/1) with blade guard (7-8/2) on the spigot (7-8/3) and align with the relevant centering device (7-8/4).

The contour of the cam disc corresponds to the contour of the knife.



**Never mount the knife without blade guard.**

**Serious injuries are possible.**

### ATTENTION

**Only use knives that match the cam disc.  
(Compare label on disc and knife).**

**Using an incorrect cam disc can damage the  
knife and machine.**

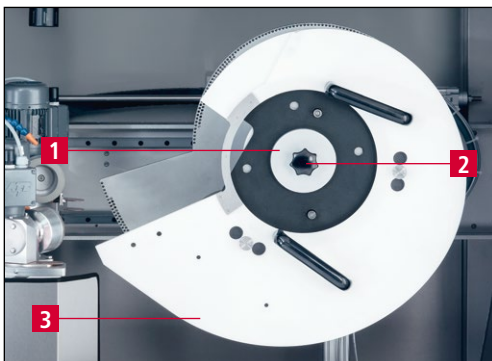

Figure 7-9 Clamp knife

Secure the knife and blade guard from falling (7-9/3) with one hand and attach the clamping flange (7-9/1); mount the star handle (7-9/2) with the other hand.

Tighten the star handle (7-9/2). Finally, remove the blade guard (7-9/3).

Close the protective doors.



# 7. Operation

---



Sharp cutting edge, can result in serious injuries.

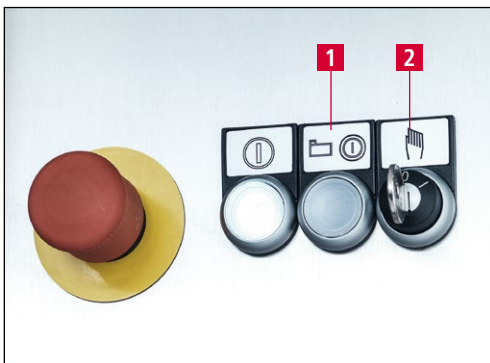

Figure 7-10 Control panel

## NOTE

Turn the "Setting Mode" key switch (7-10/2) to "0" and press the "Start/Stop" button (7-10/1).

Open the coolant taps directly on the hoses.

The machine starts the grinding process.

When the knife is in working position, press the "Start/Stop" button (7-10/1) again to stop the machine.

**Briefly pressing the "Start/Stop" button interrupts the program flow and the button flashes. The grinding program continues when the button is pressed again.**

**Pressing the "Start/Stop" button for 3 seconds aborts the program. The button no longer flashes. Pressing the button again starts the program flow once more from the beginning.**

# 7. Operation

## 7.2.4 Grinding the slicer knife with suspension attachment

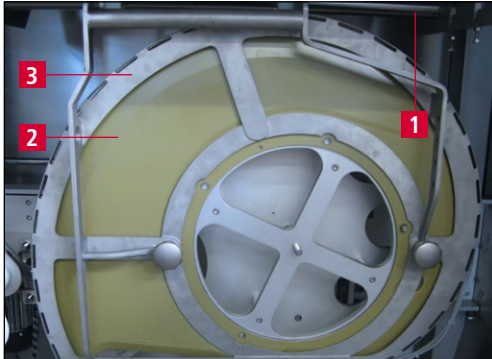

Figure 7-11 Suspension attachment

Open the protective doors.

Place the knife (7-11/2) including blade guard (7-11/3) on the respective suspension attachment (7-11/1). Place the knife (7-11/2) with guard (7-11/3) on the spigot (7-12/1).

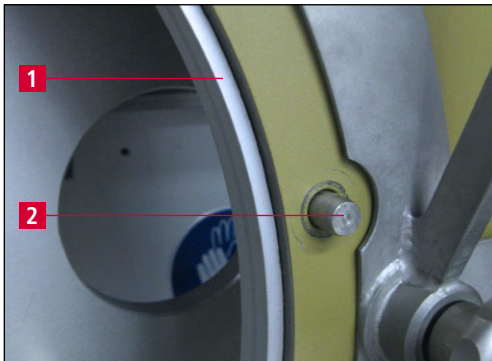

Figure 7-12 Centering device

Align using the centering device (7-12/2).

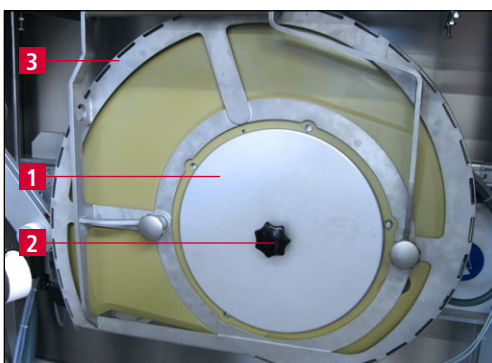

Figure 7-13 Suspension attachment

The contour of the cam disc corresponds to the contour of the knife.

Secure the knife and blade guard from falling (7-13/3) with one hand and attach the clamping flange (7-13/1); mount the star handle (7-13/2) with the other hand. Tighten the star handle (7-13/2). Finally, remove the blade guard (7-13/3).

**ATTENTION**

**Only use knives that match the cam disc.  
(Compare label on disc and knife).**

**Using an incorrect cam disc can damage the  
knife and machine.**

## 7. Operation

---

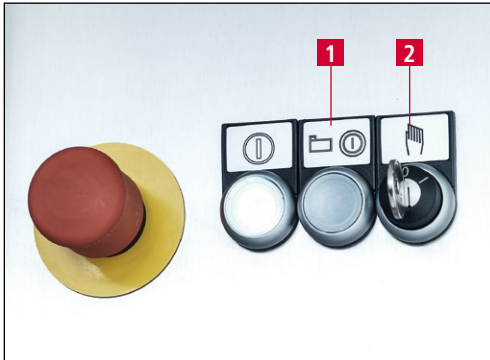

Figure 7-14 Control panel

Close the protective doors.

Turn the "Setting Mode" key switch (7-14/2) to "0" and press the "Start/Stop" button (7-14/1).

Open the coolant taps directly on the hoses.

The machine starts the grinding process.

When the knife is in working position, press the "Start/Stop" button (7-14/1) again to stop the machine.

### NOTE

**Briefly pressing the "Start/Stop" button interrupts the program flow and the button flashes. The grinding program continues when the button is pressed again.**

**Pressing the "Start/Stop" button for 3 seconds aborts the program. The button no longer flashes. Pressing the button again starts the program flow once more from the beginning.**

# 7. Operation

## 7.2.5 Grind circular knives

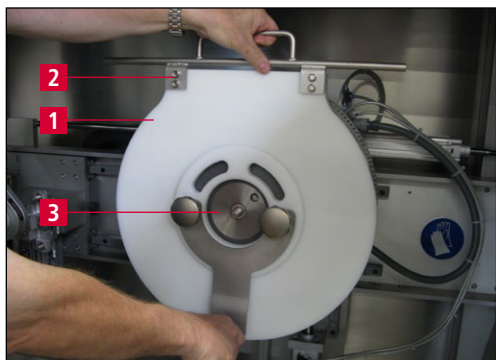

Figure 7-15 Place circular knife

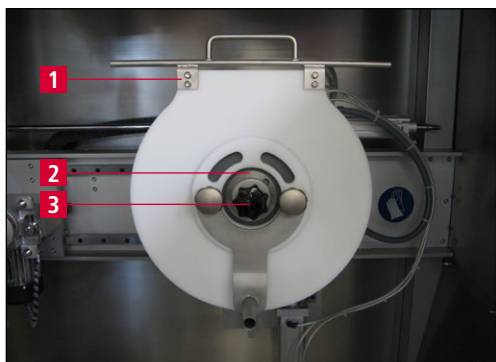

Figure 7-16 Circular knife

### ATTENTION

Open the protective doors.

Place the knife (concealed in a blade guard (7-15/1)) with guard (7-15/2) on the spigot (7-15/3).

The contour of the cam disc corresponds to the contour of the knife.

Secure the knife and blade guard from falling (7-16/1) with one hand and attach the clamping flange (7-16/2); mount the star handle (7-16/3) with the other hand.

Tighten the star handle (7-16/3). Finally, remove the blade guard (7-16/1).

Close the protective doors.

**Only use knives that match the cam disc. (Compare label on disc and knife).**

**Using an incorrect cam disc can damage the knife and machine.**

## 7. Operation

---

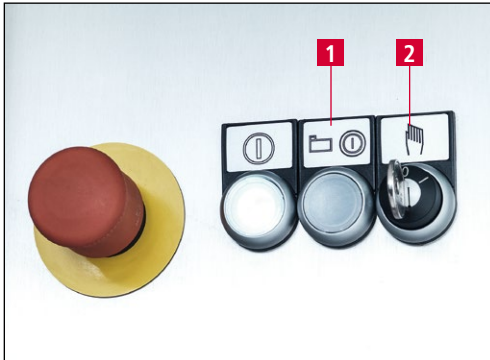

Figure 7-17 Control panel

### NOTE

Turn the "Setting Mode" key switch (7-17/2) to "0" and press the "Start/Stop" button (7-17/1).

Open the coolant taps directly on the hoses.

The machine starts the grinding process.

When the knife is in working position, press the "Start/Stop" button (7-17/1) again to stop the machine.

**Briefly pressing the "Start/Stop" button interrupts the program flow and the button flashes. The grinding program continues when the button is pressed again.**

**Pressing the "Start/Stop" button for 3 seconds aborts the program. The button no longer flashes. Pressing the button again starts the program flow once more from the beginning.**

# 7. Operation

---

## 7.2.6 Set the knife at the center of the disc

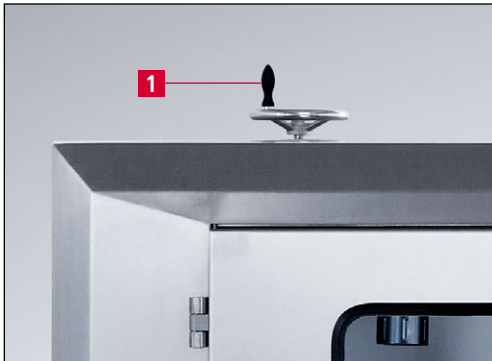

**Figure 7-18** Set knife

Adjust the knife with the hand wheel (7-18/1) in such a way that the knife edge passes through the center of the rear grinding wheel.

Check sharpness when the program ends ("Start/Stop" button no longer flashes).

If the knife is not yet sharp, mark the blade on both sides with a pencil and grind again.

The marked places indicate whether the knife has been completely ground or not. If not, adjust the grinding angle to make it steeper

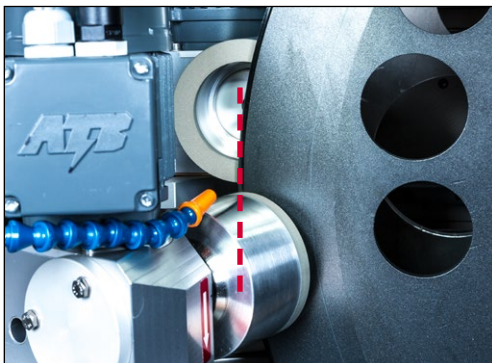

**Figure 7-19** Correct

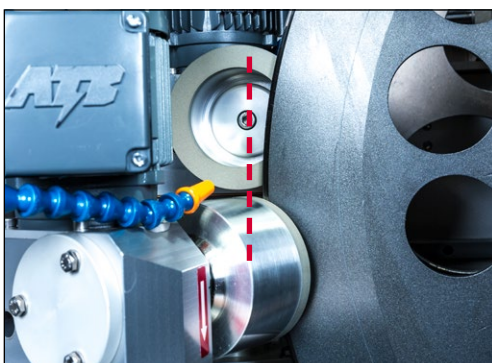

**Figure 7-20** Incorrect

# 7. Operation



**Danger of clothing and hair being pulled in. Crushing hazard for hands. Serious injuries are possible.**

**To prevent dust formation, always have the coolant tap on while dressing and direct the coolant hose at the grinding wheels.**

**Never dress with the knife clamped.**

**Serious cutting injuries are possible.**

## 7.3 Dressing the front/rear ceramic grinding wheels

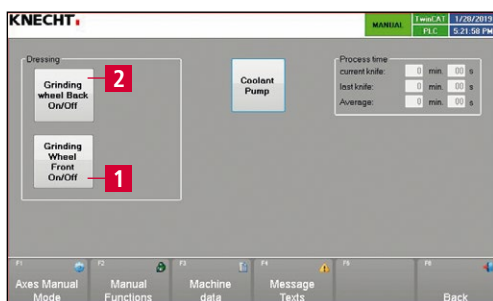

Figure 7-21 Settings

If the front grinding wheel is running out of true or is loaded, it must be dressed.

Set the grinding discs to a comfortable position (approx. 34° – see Chapter 7.5).

Change to settings via the main menu “F5 Settings” (3-8/15).

### ATTENTION

**Turn the “Setting Mode” key switch (3-7/5) to position “1”.**

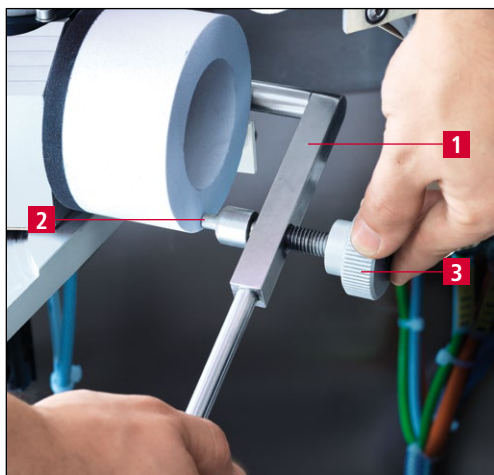

Figure 7-22 Dress front grinding wheel

Open the protective doors.

Insert the truing device (7-22/1) into the designated socket of the front grinding unit as far as it will go.

Switch on the front grinding wheel.

To do so, press “Front Grinding Wheel On/Off” (7-21/1) on the touch panel.

Move the dressing diamond (7-22/2) with the dressing device evenly over the rotating grinding wheel.

The dressing diamond is fed in by turning the feed nut (7-22/3) clockwise.

## 7. Operation

---

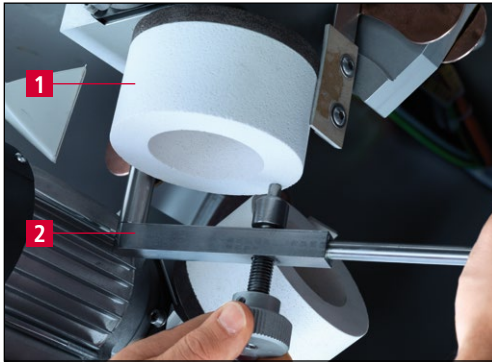

**Figure 7-23** Dress front grinding wheel

Insert the truing device (7-23/2) into the designated socket of the front grinding unit as far as it will go.

Switch on the front grinding wheel (7-23/1).

To do so, press “Front Grinding Wheel On/Off” (7-21/2) on the touch panel.

Dress the grinding wheel as described in Figure 7-22.



# 7. Operation

---

## 7.4 Changing the front/rear grinding wheels



Figure 7-24 Adjust the grinding angle

Open the protective doors.

Set the grinding discs to a comfortable position (approx. 34° – see Chapter 7.5).

**ATTENTION**

Turn the "Setting Mode" key switch (3-7/5) to position "1".

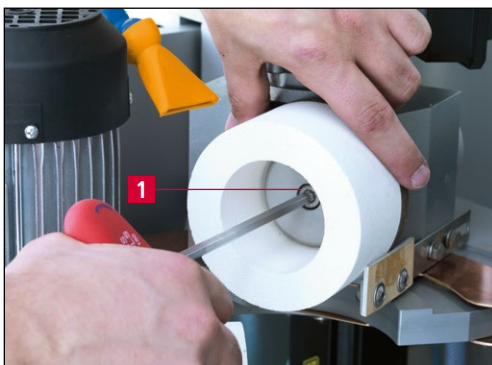

Figure 7-25 Changing the grinding wheels

With a hexagon screwdriver AF6 mm, loosen the screw in the center of the grinding wheel (7-25/1) counterclockwise and remove it.

Remove the front or rear grinding wheel and also the connection flange (7-26/1) if necessary and mount the new grinding wheel in the reverse order.

**ATTENTION**

Only original abrasives from KNECHT Maschinenbau GmbH are permitted to be used.

KNECHT Maschinenbau GmbH assumes no responsibility for the use of non-original abrasives.

# 7. Operation

---

## 7.4.1 Intermediate flange for ceramic grinding wheels



**Figure 7-26** Intermediate flange

If ceramic grinding wheels are used, an intermediate flange (7-26/1) must be mounted from a wear of 50% (less than 40 mm grinding wheel thickness).

Use the M8x40 cylinder head screw supplied for this purpose.

### **NOTE**

**Two intermediate flanges with corresponding screws are included in the accessories.**

# 7. Operation

---

## 7.5 Adjusting the grinding angle

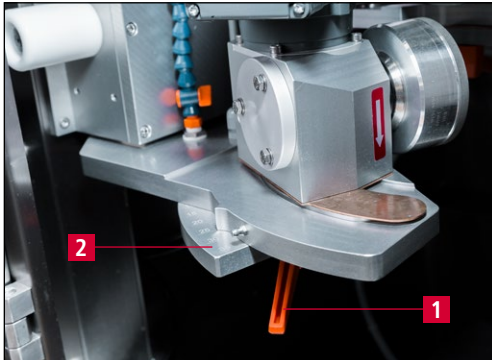

**Figure 7-27** Setting the grinding angle

The grinding angle of the front and rear grinding wheel is adjusted manually.

Release the clamping lever (7-27/1) and set the fixture to the desired angle (7-27/2). The fixture is then clamped once again using the clamping lever (7-27/1).

Proceed in the same way with the rear grinding wheel.

# 8. Control

## 8.1 Main screen

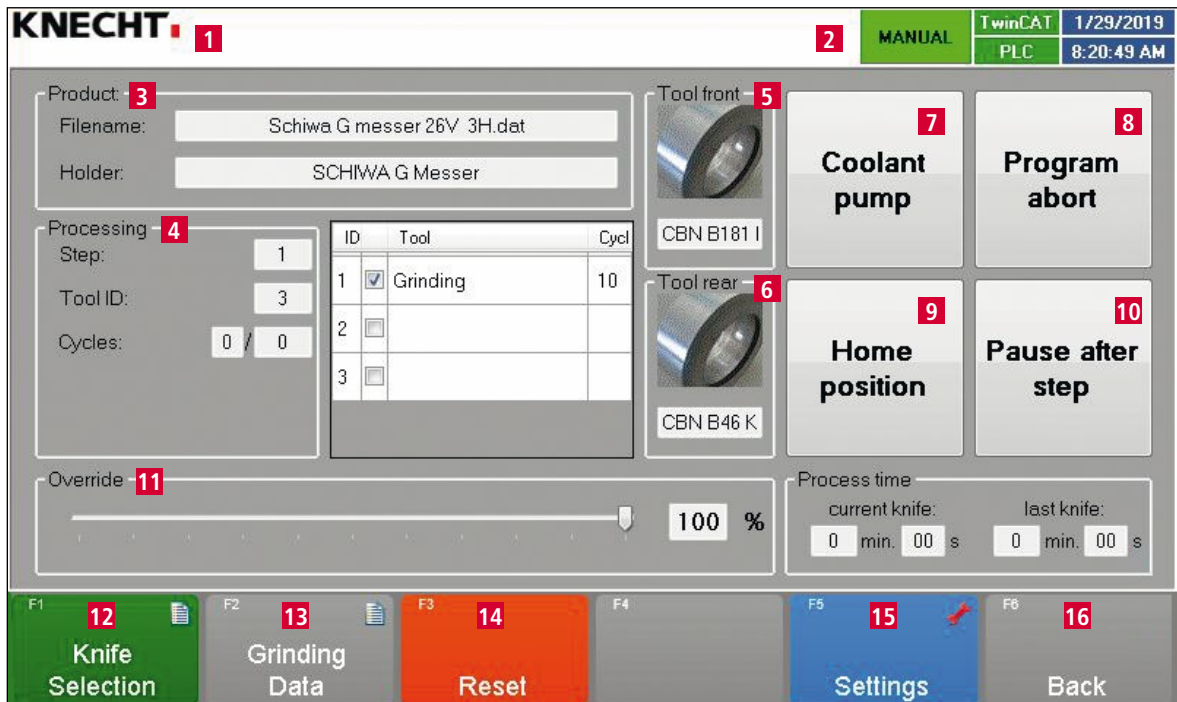

Figure 8-1 Main screen

- 1 Error messages
- 2 Status display
- 3 Product data (loaded grinding program)
- 4 Current processing step settings (stored in grinding program)
- 5 Front tool (front grinding wheel)
- 6 Rear tool (rear grinding wheel)
- 7 Coolant pump (switch coolant pump on/off)
- 8 Abort program (reset program after stop)
- 9 Home position (move grinding wheel to change position)
- 10 Break after step (program stops after current step)
- 11 Override (adapt speed to grinding disc)
- 12 **"F1 Knife Selection"**: select the desired grinding program, see Chapter 8.2
- 13 **"F2 Grinding Data"**: see Chapter 8.3
- 14 **"F3 Reset"**: delete current error
- 15 **"F5 Settings"**: see Chapter 8.4
- 16 **"F6 Back"**: return to previous screen

### NOTE

The assignment of the touch panel buttons varies according to the current display screen. The respective assignment is indicated in text form.

# 8. Control

## 8.2 Grinding program

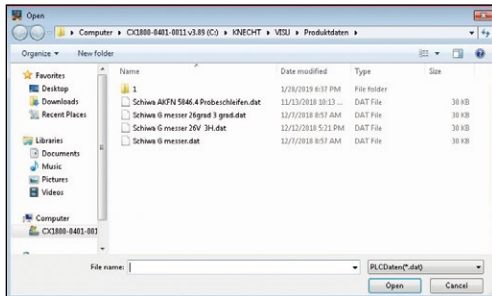

**Figure 8-2** Select grinding program

Press "F1 Knife Selection" (8-1/12) on the main screen.

The "Open" dialog box (8-2) from Windows appears. The folder "C:\Product" is automatically displayed. The grinding programs for the individual knives are filed in this folder. The grinding programs have the ending ".dat" in the file name.

To load a grinding program, proceed as follows: Select the desired grinding program. The name of the selected grinding program appears in the File Name column. The grinding program is loaded with one click on the "Open" button.

The "Open" dialog box is closed and the selected grinding program is displayed in the main menu.

# 8. Control

## 8.3 Grinding data

The data for the grinding process are entered via the main menu "F2 Grinding Data" (8-1/13). These data vary according to the knife. The data are saved in a file and can be loaded again from the file.

### ATTENTION

Changing the grinding data can cause malfunction and damage to the machine. Changes may only be made under the supervision of KNECHT technicians or by persons who have been trained by KNECHT Maschinenbau.

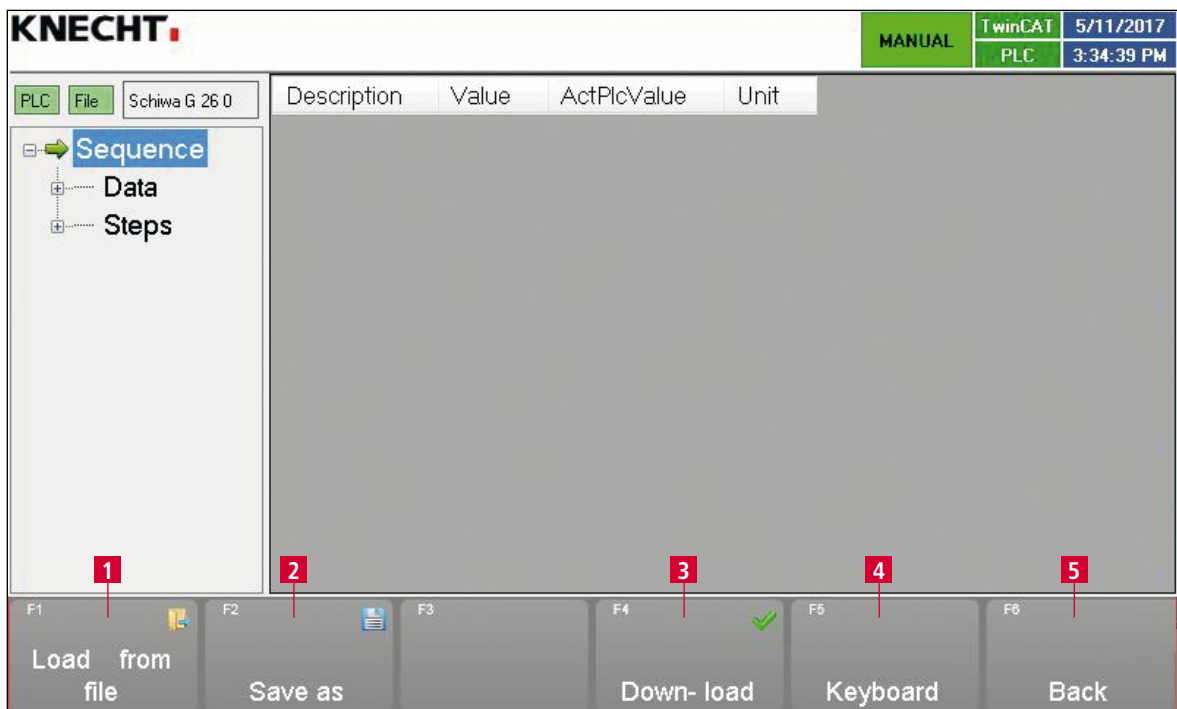

Figure 8-3 Grinding data

- 1 "F1 Load from File"
- 2 "F2 Save As"
- 3 "F4 Accept"
- 4 "F5 Keyboard"
- 5 "F6 Back": return to previous screen

# 8. Control

## 8.3.1 Data

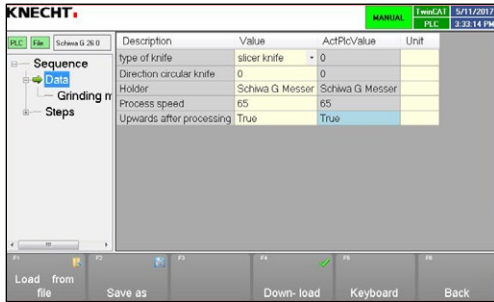

Figure 8-4 Grinding data "Data"

**Type of knife:** Circular/sickle knife

**Direction circular Knife:** 0 = left, 1 = right

**Holder:** Index as to which holder will be used for processing the knife

**Process Speed:** Processing speed at which the cam disc rotates during the grinding process (mm/s)

**Upwards after processing:** true = yes, false = no (for better assembly or assembly with suspension protection)

## 8.3.2 Abrasives

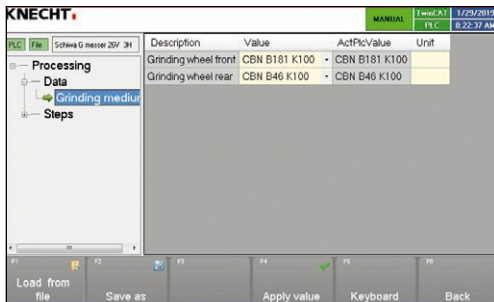

Figure 8-5 Grinding data "Abrasives"

**Grinding wheel front**

**Grinding wheel rear**

## 8.3.3 Steps

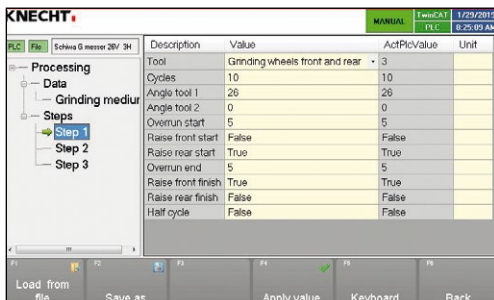

Figure 8-6 Grinding data "Steps"

**Tool:** Selection of the abrasives

**Cycles:** Number 1, 2, 3

**Angle Tool 1 (front):** Angle adjustment of front grinding wheel (the set grinding angle is displayed. Grinding wheel adjustment – Chapter 7.5)

**Angle Tool 2 (rear):** Angle adjustment of rear grinding wheel (the set grinding angle is displayed. Grinding wheel adjustment – Chapter 7.5)

**Overrun Start:** Distance limit switch is reached

**Front lift off Start:** Front grinding wheel is raised, true = yes, false = no

**Back lift off Start:** Rear grinding wheel is raised, true = yes, false = no

**Overrun end:** Distance limit switch is reached

**Front lift off End:** Front grinding wheel is raised from knife, true = yes, false = no

## 8. Control

---

**Back lift off End:** Rear grinding wheel is raised from knife, true = yes, false = no

**Half Cycle:** Tool only does half cycle



# 8. Control

## 8.4 Settings

Machine settings other than the basic functions of “Start” or “Stop” are applied using “F5 Settings” (8-1/15) in the main menu.

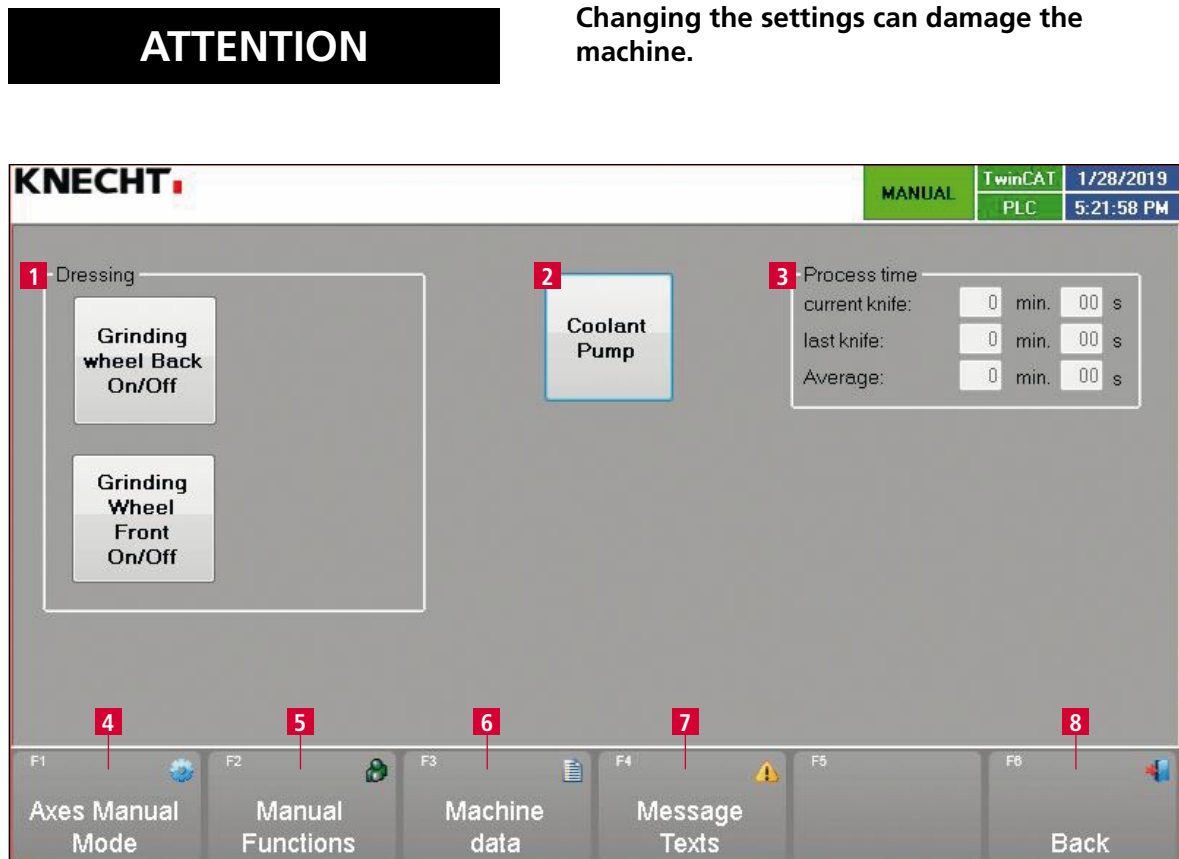

Figure 8-7 Settings

- 1 Dressing (switch grinding wheels on/off or move into dressing position)
- 2 Coolant pump (switch coolant pump on/off)
- 3 Processing period (current knife, last knife and average in mins/secs)
- 4 **“F1 Axes Manual Mode”**: Axes are moved individually in manual mode
- 5 **“F2 Manual Functions”**: Allows manual operation of the machine
- 6 **“F3 Machine Data”**: For displaying/editing machine data that has been set ex-factory
- 7 **“F4 Message Texts”**: Display all error messages sequentially (number of messages, frequency, start)
- 8 **“F6 Back”**: return to previous screen

# 8. Control

## 8.5 Axes manual mode

Access the sub-menu "F1 Axes Manual Mode" (8-7/4) via the main menu "F5 Settings" (8-1/15). The "Axes Manual Mode" (8-8) display screen shows the status of the CNC driven machine axes. The axes can also be controlled manually. The individual axis positions are displayed at the top left of the sub-menu "Axes Manual Mode".

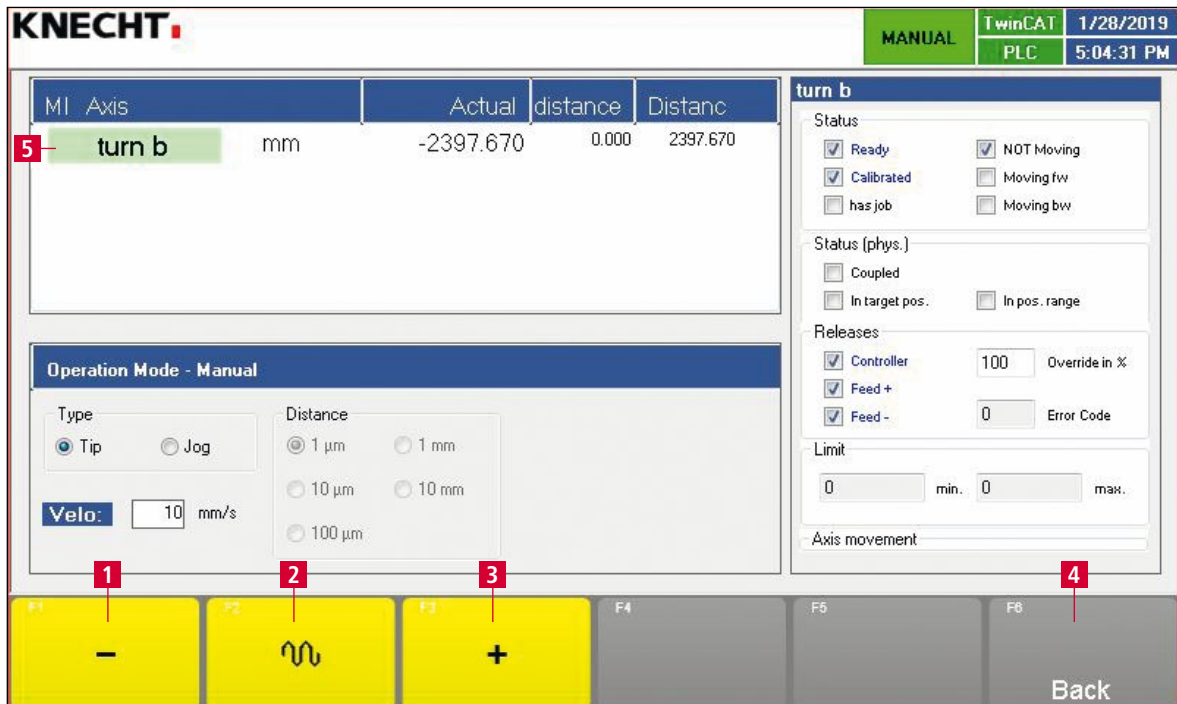

Figure 8-8 Settings "Axes manual mode"

- 1 "-" : Move the selected axes in "-" direction (backwards)
- 2 "~" : in combination with "-" or "+" activate rapid traverse in the relevant direction
- 3 "+" : Move the selected axes in "+" direction (forwards)
- 4 "F6 Back" : return to previous screen
- 5 Cam disc drive

# 8. Control

## 8.6 Manual functions

The manual functions allow you to operate the machine by hand. They can be accessed via the main menu "F5 Settings" (8-1/15) followed by "F2 Manual Functions" (8-7/5). Various functions of the machine can be individually enabled.

### ATTENTION

Buttons highlighted in green are enabled. Buttons highlighted in gray are disabled.

### NOTE

Manual functions are not required in normal operation. During maintenance work (e.g. when changing grinding wheels), the individual machine components can be moved to a more easily accessible position using the manual functions.

### 8.6.1 General

When the sub-menu "F2 Manual Functions" (8-7/5) is accessed, the screen initially switches to the general manual functions (8-9).

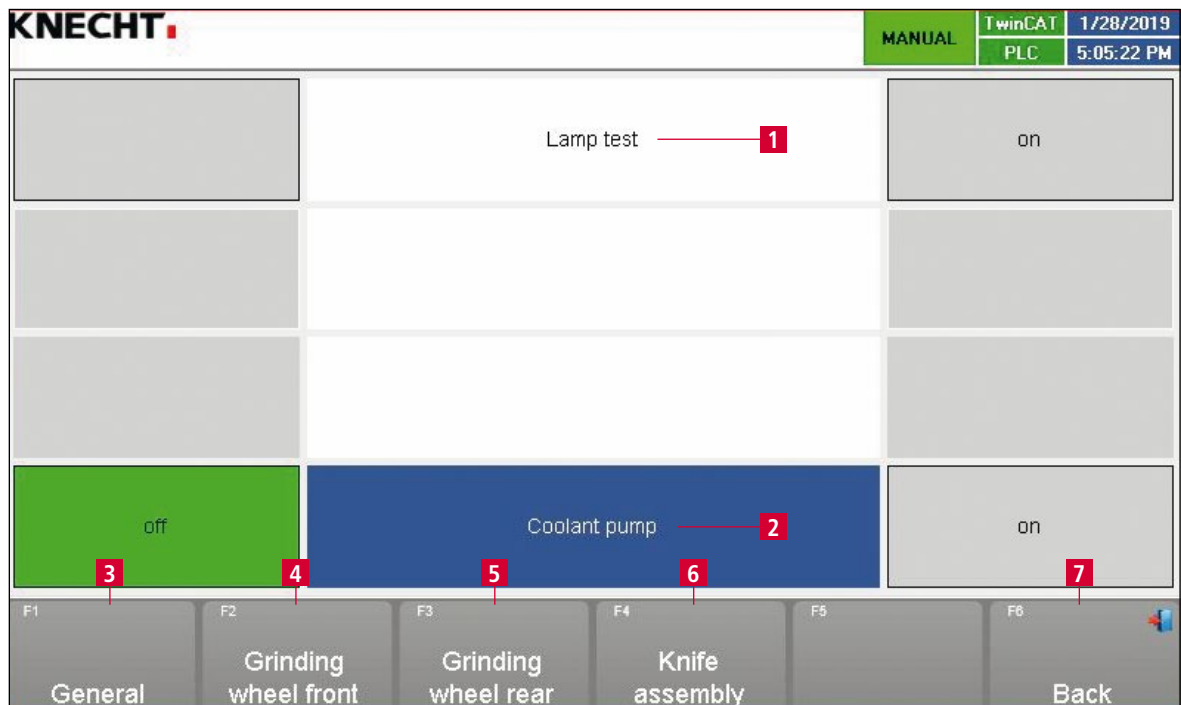

Figure 8-9 Manual functions "General"

- 1 Switch on all lamps
- 2 Switch coolant pump on/off
- 3 "F1 General" (current screen)

# 8. Control

- 4 **"F2 Front Grinding Wheel"**: see Chapter 8.6.2
- 5 **"F3 Rear Grinding Wheel"**: see Chapter 8.6.3
- 6 **"F4 Knife Package"**: see Chapter 8.6.4
- 7 **"F6 Back"**: return to previous screen

## 8.6.2 Grinding wheel front

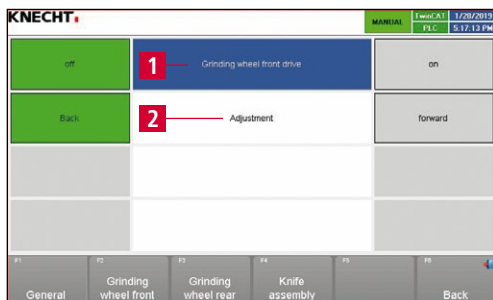

- 1 Switch on/off front grinding wheel drive
- 2 Move grinding wheel forwards/backwards

Figure 8-10 Manual functions "Grinding wheel front"

## 8.6.3 Rear grinding wheel

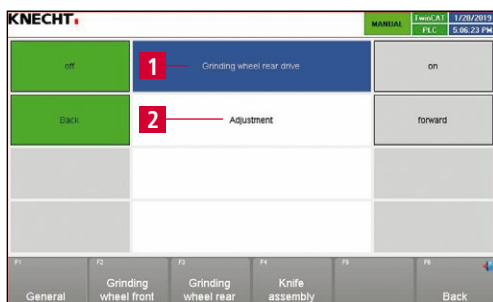

- 1 Switch on/off rear grinding wheel drive
- 2 Move grinding wheel forwards/backwards

Figure 8-11 Manual functions "Grinding wheel rear"

## 8.6.4 Knife holder

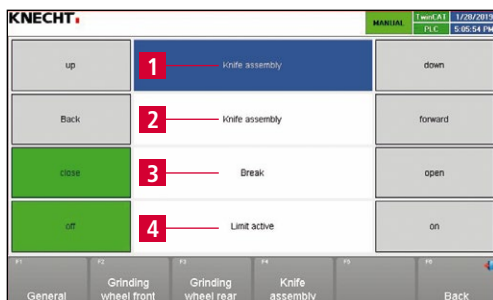

- 1 Move knife package up/down
- 2 Move knife package forwards/backwards
- 3 Open/close brake
- 4 Switch on/off limits (machine does not move beyond the limit switches in manual mode)

Figure 8-12 Manual functions "Knife package"

## 8. Control

---

### **ATTENTION**

Only open the brake when the knife package has previously been moved away and forwards. Otherwise there is a risk of damage to the machine, since the cam disc can impact against the side wall in an uncontrolled manner.

# 8. Control

## 8.7 Machine data

Access the sub-menu "F3 Machine Data" (8-7/6) via the main menu "F5 Settings" (8-1/15). The "Machine Data" display (8-13) shows the basic machine settings. The data are saved in a file and can be loaded again from the file.

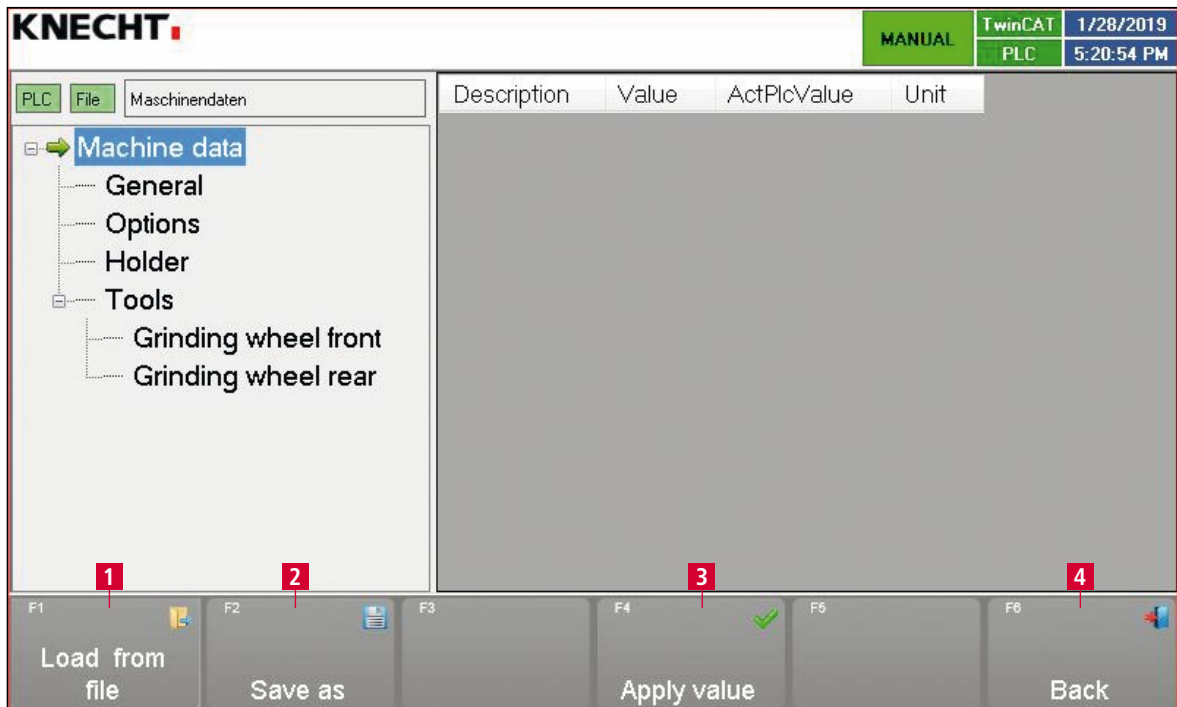

Figure 8-13 Machine data

- 1 "F1 Load from File"
- 2 "F2 Save As"
- 3 "F4 Accept"
- 4 "F6 Back": return to previous screen

### 8.7.1 General

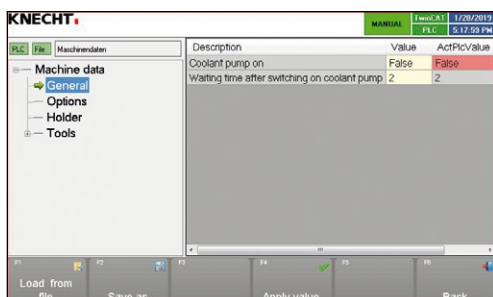

Figure 8-14 Machine data "General"

**Coolant pump on:** true = always on,  
false = only on at program start

**Waittime after coolant pump on:** (in secs)

# 8. Control

## 8.7.2 Options

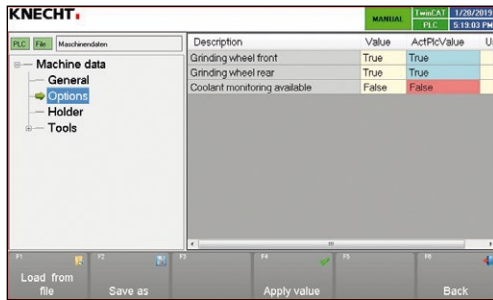

Figure 8-15 Machine data "Options"

**Grinding wheel front:** true = available,  
false = not available

**Grinding wheel rear:** true = available,  
false = not available

**Coolant monitoring available:** true = yes,  
false = no

## 8.7.3 Support

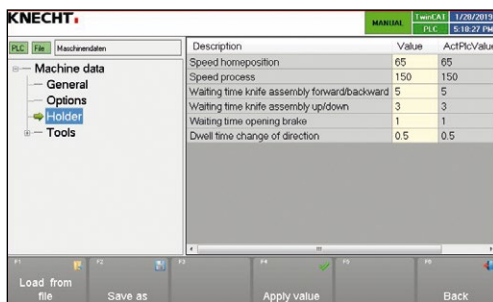

Figure 8-16 Machine data "Support"

**Speed Homeposition:** (mm/s)

**Speed process:** (mm/s)

**Waittime knife forward / backward:** (in secs)

**Waittime knife up / down:** (in secs)

**Waittime opening brake:** (in secs)

**Waittime when changing direction:** (in secs)

## 8.7.4 Tools – Grinding wheel front / rear

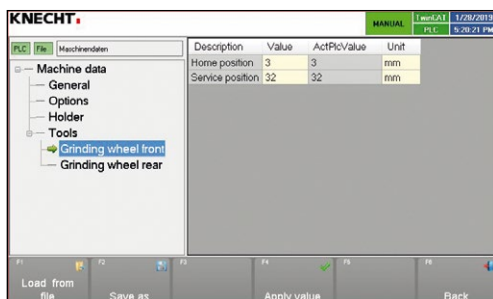

Figure 8-17 Machine data "Grinding wheel front/rear"

**Home Position:** (in mm)

**Service Position:** (in mm)

# 8. Control

## 8.8 Message texts

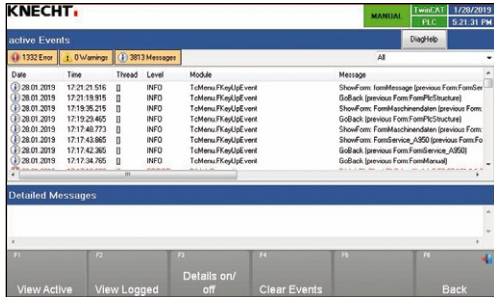

Figure 8-18 Message texts

The Message Texts screen (8-18) serves only to display the status messages of the machine in detail.

The Message Texts screen provides an overview of the number of errors that are hindering the operation of the machine at a particular moment. Furthermore, the sub-menu provides information on which errors have occurred and since when they have been active.

### NOTE

**No settings can be applied in the Message Texts sub-menu. The errors also appear in the upper part of the main screen (8-1/1).**



# 8. Control

## 8.9 Options

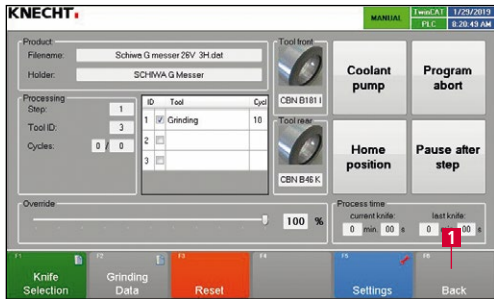

Figure 8-19 Main screen

Other options such as language settings can be accessed via the main menu.

Press "F6 Back" (8-19/1) on the touch panel to get back to the start screen.

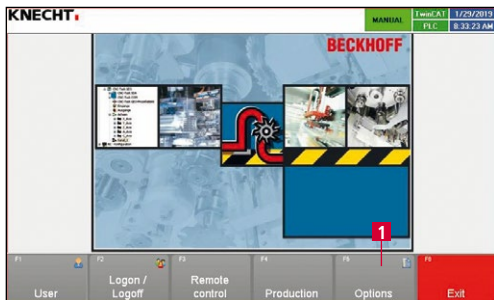

Figure 8-20 Start screen

Press "F5 Options" (8-20/1) on the touch panel.

A new window (8-21) opens.

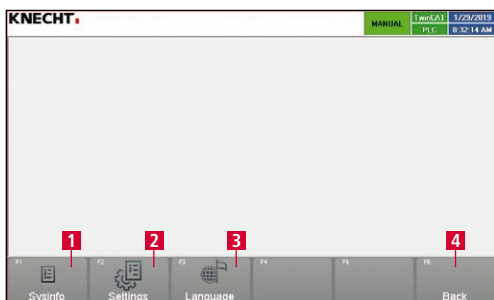

Figure 8-21 Options

- 1 "F1 Sysinfo"
- 2 "F2 Settings"
- 3 "F3 Language": change language
- 4 "F6 Back": return to previous screen

# 8. Control

## 8.10 Language

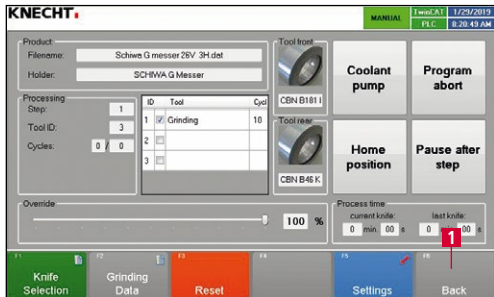

Figure 8-22 Main screen

The user interface language can be changed to the language of the country of use.

In the main menu, press "F6 Back" (8-22/1) on the touch panel to get back to the start screen.

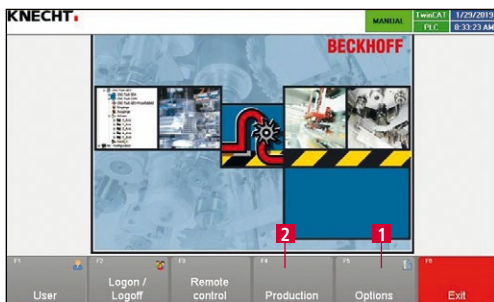

Figure 8-23 Start screen

Press "F5 Options" (8-23/1) on the touch panel.

A new window (8-24) opens.

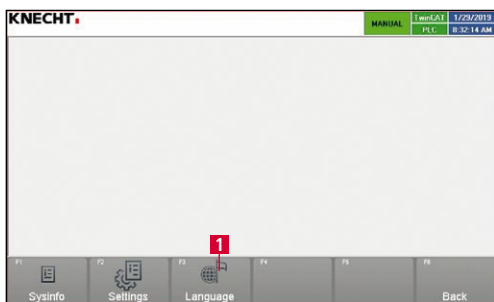

Figure 8-24 Options

Use "F3 Language" (8-24/1) to open the language selection (8-25).

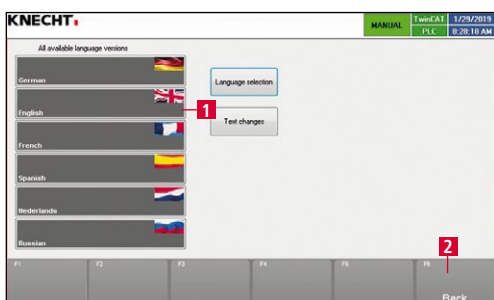

Figure 8-25 Select language

The desired language is selected and automatically activated by pressing the corresponding touch panel button (8-25/1).

Then press "F6 Back" (8-25/2) on the touch panel to return to the start screen.

The main screen appears on pressing "F4 Production" (8-23/2).

## 8. Control

---

### 8.11 Setting up an internet connection

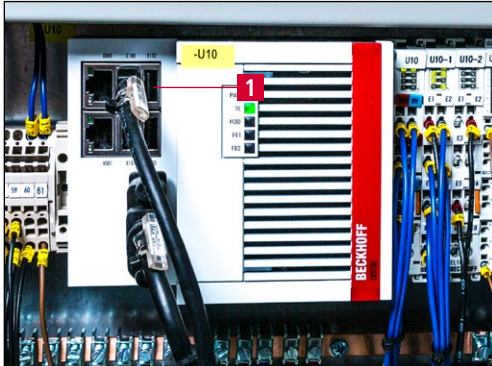

Figure 8-26 Network connection

The machine is equipped with an ethernet port. A secure connection between the machine and KNECHT Maschinenbau GmbH can be established via the integrated VPN router. The connection can be activated or deactivated by the operator using the key switch on the control cabinet (8-26/1).

This connection gives the KNECHT service technician access to the control and allows him to diagnose the machine, change the software settings and upload or edit new grinding programs.

There must be an active Internet connection to initiate the connection.

#### NOTE

**When commissioning, the VPN router is configured according to the specified IT infrastructure so that the machine communicates exclusively with KNECHT Maschinenbau GmbH via the VPN server. Any communication within the customer network is excluded. The customer network is therefore optimally protected.**

**In order to establish the internet connection, plug the supplied ethernet cable into the on-site network socket (RJ45) and the network port on the control cabinet of the grinding machine.**

## 9. Care and maintenance

---



For all work on the grinding machine, observe the locally applicable safety and accident prevention regulations as well as instructions in the "Safety" and "Important notes" section of the operating instructions.

### 9.1 Coolant

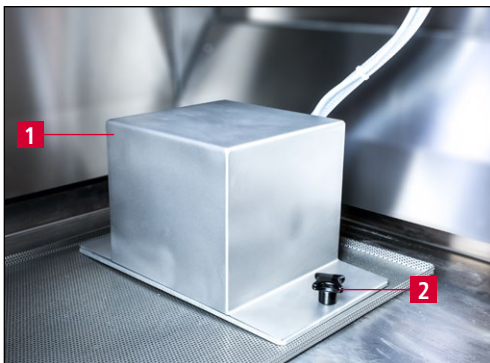

Figure 9-1 Water tray

The cooling water has to be replaced every week and the water tray must be cleaned.

The water tray must always be filled with water up to 3 cm below the rim. The water tray can be pulled out in front for filling and cleaning.

The pump (9-1/1) including the guard can be removed by loosening and removing the star handles (9-1/2).

### 9.2 Clean the grinding machine

The machine must be cleaned after each grinding operation, otherwise the grinding abrasion dries and is difficult to remove.

For pre-cleaning, we recommend a commercially available wet vacuum cleaner. For final cleaning we recommend soft cleaning cloths.

Clean the windows with soft cleaning cloths and window cleaning agent.

After cleaning the grinding machine, we recommend using the products listed in the Cleaning agent and lubricant table for care of the machine (see Chapter 9.2.1).

**ATTENTION**

**The grinding machine must not be sprayed with water. Machine components may be damaged or destroyed.**

# 9. Care and maintenance

## 9.2.1 Cleaning agent and lubricant table

Cleaning / Lubrication work	Interflon	WÜRTH	SHELL	EXXON Mobil	OEST
Cleaning and care of machine parts	Dry Clean Stainless Steel	Stainless steel care spray	Risella 917	Marcol 82	New Process Multispray
Lubrication of threads and sliding surfaces	Fin Grease	Multi-purpose grease	Gadus S2 V1002	Mobilith SHC 100	Multi-purpose grease LT 190 EP
Lubrication nipples	Grease MP00		Gadus S5 V142 W0018		IXELON LT 000 EP

## 9.3 Maintenance plan (one-shift operation)

Interval	Assembly	Maintenance task
Daily	All machine surfaces	Clean with soft cleaning cloth and care spray.
	Slide angle adjustment	Clean angle adjustment with brush and cleaning cloth and oil.
Weekly	Star handle threads	Lubricate with multi-purpose grease.
	Water tray	Replace coolant and clean water tray.
	Slide angle adjustment	Lubricate lubrication nipple with grease.
Monthly		Clean and oil steel shafts.
	Slide grinding wheels	Lubricate lubrication nipple with grease (see Chapter 9.4.1).
	Axes	Lubricate lubrication nipple with grease (see Chapter 9.4.2).
	Safety doors	Lubricate the guides of the safety doors.
Annually		Contact the service department of KNECHT Maschinenbau GmbH.

# 9. Care and maintenance

---

## 9.4 Lubrication points

### 9.4.1 Lubricating the cross slide

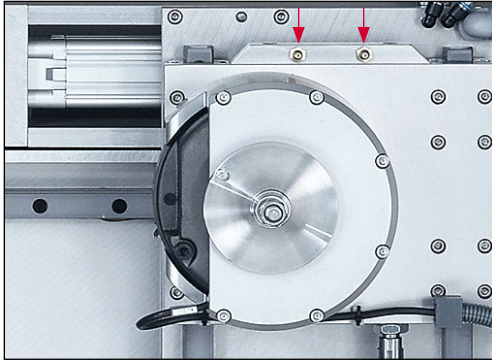

**Figure 9-2** Lubricating the cross slide

Place the oil press on the lubrication nipples and lubricate the cross slide.

We recommend "OEST IXELON LT 000 EP" or a corresponding commercial fluid grease.

Press one stroke of grease into the lubrication point once a month

### 9.4.2 Lubricating the grinding wheel slide

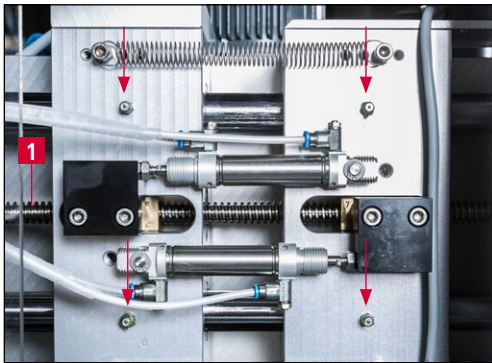

**Figure 9-3** Lubricating the grinding wheel slide

Press one round of grease into the lubrication points at the marked places once a month using the oil press.

We recommend "OEST IXELON LT 000 EP" or a corresponding commercial fluid grease.

Grease the spindle (9-3/1) once every month.

# 10. Disassembly and disposal

---

## 10.1 Disassembly

The operating materials must be disposed of correctly.

Secure moving parts against slippage.

Disassembly must be conducted by a qualified specialist.

## 10.2 Disposal

At the end of service life, the machine must be disposed of by a qualified specialist company. In exceptional situations, and after consultation with KNECHT Maschinenbau GmbH, the machine may be returned.

Operating materials (e.g. grinding wheels, coolants etc.) must also be disposed of correctly.

# 11. Service, spare parts and accessories

---

## 11.1 Postal address

KNECHT Maschinenbau GmbH  
Witschwender Straße 26  
88368 Bergatreute  
Germany

Phone +49-7527-928-0  
Fax +49-7527-928-32

mail@knecht.eu  
www.knecht.eu

## 11.2 Service

### **Service line:**

For address, see postal address

service@knecht.eu

## 11.3 Wear and spare parts

If you need spare parts, please use the spare parts list provided with the machine. Please place your order using the format described below.

### **When ordering, please always provide: (example)**

Machine type	(A 950 III)
Machine number:	(1230870950-III)
Designation of assembly	(Knife drive)
Designation of individual part	(Drive wheel VA assembly)
Item number (position number)	(1)
Drawing number (Article number)	(013AA11-13993)
Quantity	(1 pc)

We are always happy to answer any questions.



# 11. Service, spare parts and accessories

---

## 11.4 Accessories

### 11.4.1 Abrasives used etc.

Designation	Dimensions	Article number	Note
Boron nitride grinding wheel 15/10 K300NA-B46-C60	d.100x60x40	412F-73-1510-46	installed on delivery

#### **ATTENTION**

**Only original abrasives, wear and spare parts from KNECHT Maschinenbau GmbH are permitted to be used.**

**KNECHT Maschinenbau GmbH assumes no responsibility for the use of non-original parts.**

If you require abrasives or other accessories, please contact our sales staff and distributors, or KNECHT Maschinenbau GmbH directly.

Thank you for choosing KNECHT!

# 12. Appendix

---

## 12.1 EU Declaration of Conformity

in accordance with the EC Directive 2006/42/EC

- Machinery 2006/42/EU
- Electromagnetic Compatibility 2014/30/EU

We hereby declare that the machine designated as follows, due to its construction and design, as well as the version we placed on the market, complies with the relevant fundamental safety and health requirements of the applicable EU Directive.

In case of a modification of the machine not agreed with us, this declaration loses its validity.

<b>Designation of the machine:</b>	Grinding Machine for Sickle-shaped and Circular Knives
<b>Model designation:</b>	A 950 III
<b>Machine number:</b>	from no. 1230870950-III
<b>Applicable harmonized standards, in particular:</b>	DIN EN ISO 12100 DIN EN ISO 13849-1 DIN EN ISO 13857 DIN EN ISO 16089 DIN EN 61000-3-2 DIN EN 61000-3-3 DIN EN 55014-1 DIN EN 349
<b>Responsible for documentation:</b>	Peter Heine (B. Eng. Mechanical Engineering BA) Phone +49-7527-928-40
<b>Manufacturer:</b>	KNECHT Maschinenbau GmbH Witschwender Straße 26 88368 Bergatreute Germany

A complete technical documentation is available. The operating instructions document for the machine is available in its original version and in the native language of the user.

The validity of the declaration expires in the event of changes to the legal requirements.

Bergatreute, March 4, 2024

KNECHT Maschinenbau GmbH



Markus Knecht  
CEO

