

## Operating Instructions

### **EVO 5**

Hand Knife Sharpening Machine



# Operating Instructions

---

## Hand Knife Sharpening Machine EVO 5

### Manufacturer

KNECHT Maschinenbau GmbH  
Witschwender Straße 26  
88368 Bergatreute  
Germany

Phone +49-7527-928-0  
Fax +49-7527-928-32

mail@knecht.eu  
www.knecht.eu

### Documents for machine operator

Operating instructions

### Date of issue of the operating instructions

September 29, 2020

### Copyright

The copyright for these operating instructions as well as other documents for the machine operator is held by KNECHT Maschinenbau GmbH. They are provided only to customers and operators of our products and are included with the machine.

These documents may neither be reproduced, nor made accessible to third parties, in particular rival firms, without our express permission.

# Table of Contents

---

<b>1.</b>	<b>Important notes</b>	<b>7</b>
<b>1.1</b>	<b>Preface to the operating instructions</b>	<b>7</b>
<b>1.2</b>	<b>Warnings and symbols in the operating instructions</b>	<b>7</b>
<b>1.3</b>	<b>Warning signs and their meaning</b>	<b>8</b>
1.3.1	Warning and mandatory signs on the grinding machine	8
1.3.2	General warning and mandatory signs	8
<b>1.4</b>	<b>Rating plate and serial number</b>	<b>10</b>
<b>1.5</b>	<b>Figure and item numbers in the operating instructions</b>	<b>10</b>
<b>2.</b>	<b>Safety</b>	<b>11</b>
<b>2.1</b>	<b>Basic safety instructions</b>	<b>11</b>
2.1.1	Observe notes in the operating instructions	11
2.1.2	Obligation on the part of the operator	11
2.1.3	Obligation on the part of the personnel	11
2.1.4	Hazards involved in handling the grinding machine	11
2.1.5	Malfunctions	12
<b>2.2</b>	<b>Intended use</b>	<b>12</b>
<b>2.3</b>	<b>Warranty and liability</b>	<b>12</b>
<b>2.4</b>	<b>Safety regulations</b>	<b>13</b>
2.4.1	Organizational measures	13
2.4.2	Protective equipment	13
2.4.3	Informal safety measures	13
2.4.4	Selection and qualification of personnel	13
2.4.5	Machine control system	14
2.4.6	Safety measures in normal operation	14
2.4.7	Hazards due to electrical power sources	14
2.4.8	Particular hazard zones	14
2.4.9	Servicing (maintenance, repair) and fault rectification	14
2.4.10	Structural alterations to the grinding machine	15
2.4.11	Cleaning the machine	15
2.4.12	Oils and greases	15
2.4.13	Relocation of the grinding machine	15
<b>3.</b>	<b>Description</b>	<b>16</b>
<b>3.1</b>	<b>Intended use</b>	<b>16</b>
<b>3.2</b>	<b>Technical specifications</b>	<b>16</b>
3.2.1	General information	16
<b>3.3</b>	<b>Functional description</b>	<b>17</b>
<b>3.4</b>	<b>Description of components</b>	<b>18</b>
3.4.1	Control panel	19

# Table of Contents

---

<b>4.</b>	<b>Transport</b>	<b>20</b>
4.1	Transport aids	20
4.2	Transport damage	20
4.3	Transport to another installation site	20
<b>5.</b>	<b>Installation</b>	<b>21</b>
5.1	Selection of qualified personnel	21
5.2	Installation site	21
5.3	Supply connections	21
5.4	Settings	21
5.5	Initial start-up of the grinding machine	22
<b>6.</b>	<b>Commissioning</b>	<b>23</b>
<b>7.</b>	<b>Operation</b>	<b>24</b>
7.1	General grinding fundamentals	24
7.2	Turning on the grinding machine	24
7.3	Adjusting the grinding angle	24
7.4	Sharpening the hand knives on the wet-grinding wheel	25
7.5	Polishing and deburring on the polishing disk	26
7.6	Replacing the wet-grinding wheel	27
7.7	Replacing the polishing disk	29
7.8	Suction unit (optional)	31
<b>8.</b>	<b>Care and maintenance</b>	<b>32</b>
8.1	Cleaning	32
8.1.1	Lubrication schedule and lubricant table	32
8.2	Maintenance plan (one-shift operation)	32
<b>9.</b>	<b>Disassembly and disposal</b>	<b>33</b>
9.1	Disassembly	33
9.2	Disposal	33

# Table of Contents

---

<b>10.</b>	<b>Service, spare parts and accessories</b>	<b>34</b>
<b>10.1</b>	<b>Postal address</b>	<b>34</b>
<b>10.2</b>	<b>Service</b>	<b>34</b>
<b>10.3</b>	<b>Wear and spare parts</b>	<b>34</b>
<b>10.4</b>	<b>Accessories</b>	<b>35</b>
10.4.1	Abrasives used, etc.	35
<b>11.</b>	<b>Annex</b>	<b>36</b>
<b>11.1</b>	<b>EU Declaration of conformity</b>	<b>36</b>

# 1. Important notes

---

## 1.1 Preface to the operating instructions

These operating instructions are intended to make it easier to get to know the hand knife sharpening machine, referred to in this document as grinding machine, and to use it properly for the intended purpose.

The operating instructions contain important information on how to operate the grinding machine safely, properly and cost-effectively. Observance of these instructions helps to avoid hazards, reduce repair expenses and downtimes, and to increase the reliability as well as service life of the grinding machine.

The operating instructions must always be available at the place of use of the grinding machine.

The operating instructions must be read and used by all persons entrusted with working on the grinding machine, e.g. those entrusted with:

- transport, installation, commissioning
- operation, including troubleshooting in the process flow, as well as
- upkeep (maintenance, repair).

In addition to the operating instructions and the binding accident prevention regulations applicable in the country of use and at the place of use of the machine, the generally acknowledged rules of technology with regard to safe and professional work practices are to be observed.

## 1.2 Warnings and symbols in the operating instructions

Heeding the following safety alert symbols/designations used in the operating instructions is absolutely necessary:



The hazard triangle with the signal word "CAUTION" is a work safety indicator for all work for which there is a risk of serious or fatal injury.

Special care and caution must be exercised when carrying out such work.



"ATTENTION" is used to draw attention to particular points in order to avoid damage to and/or destruction of the grinding machine or its environment.



"NOTICE" refers to user tips and especially useful information.

# 1. Important notes

---

## 1.3 Warning signs and their meaning

### 1.3.1 Warning and mandatory signs on the grinding machine

The following warning and mandatory signs have been affixed to the grinding machine:



**CAUTION! RISK OF INJURY FROM GRINDING PARTICLES  
(mandatory sign on the front plate of the machine)**

Sharpening, polishing and dressing gives rise to abrasive particles which could enter the eyes.

Wearing protective goggles is mandatory when carrying out such work.



**CAUTION! PULL OUT THE MAINS PLUG BEFORE OPENING!  
(mandatory sign on the knife guide unit and polishing disk cover)**

The grinding machine must be separated from the mains supply before the replacement of a grinding or polishing disk.

### 1.3.2 General warning and mandatory signs

The following general warning and mandatory signs must be followed:



**CAUTION! DANGEROUS ELECTRICAL VOLTAGE**

On being connected to the current supply (1x 230 V), the grinding machine becomes electrically live and touching its live parts directly could be life-threatening.

Current-carrying device parts may only be opened by authorized personnel.

The grinding machine must be separated from the mains supply before carrying out servicing, maintenance and repair work on it.

# 1. Important notes

---



## **CAUTION! RISK OF INJURY FROM KNIFE**

Working with the grinding machine means grinding knives that could cause serious cut injuries due to their sharpness.

Caution when transporting blades. Use the protective equipment provided by the knife manufacturer. Protective gloves and safety shoes must be worn.



# 1. Important notes

---

## 1.4 Rating plate and serial number



Figure 1-1 Rating plate

The rating plate is located on the rear panel of the machine.



Figure 1-2 Machine serial number

The machine serial number can be found on the rating plate and on the base plate behind the grinding unit (see arrow).

## 1.5 Figure and item numbers in the operating instructions

If the text makes a reference to a machine component which is depicted in a figure, the figure and item number will be given in parentheses.

Example: (7-1/1) means Figure number 7-1, item 1.



Figure 7-1 Adjusting the grinding angle

*To adjust the grinding angle, loosen the knurled nut (7-1/1), set the desired grinding angle (7-1/2) and tighten the nut again.*

## 2. Safety

---

### 2.1 Basic safety instructions

#### 2.1.1 Observe notes in the operating instructions

The basic prerequisite for the safe handling and uninterrupted operation of this grinding machine is knowledge of the basic safety instructions and regulations.

- These operating instructions contain important notes on how to operate the grinding machine safely.
- All persons carrying out work on the grinding machine must follow these operating instructions, in particular the safety notices.
- In addition, the rules and regulations regarding accident prevention at the place of use are to be observed.

#### 2.1.2 Obligation on the part of the operator

The operator is obliged to allow only those persons to work on the grinding machine, who

- are familiar with the basic occupational safety and accident prevention regulations and have received instruction in handling the grinding machine,
- have read and understood the operating instructions, in particular the section entitled "Safety" and the warning notes, and have provided signed confirmation of this.

The safety-awareness of the personnel at work will be monitored at regular intervals.

#### 2.1.3 Obligation on the part of the personnel

All personnel working on the grinding machine shall be obliged, before starting work, to

- observe basic occupational safety and accident prevention regulations,
- read the operating instructions, particularly the section entitled "Safety" and the warning notes, and provide signed confirmation that they have understood them.

#### 2.1.4 Hazards involved in handling the grinding machine

The grinding machine has been built to the latest technological standards and the recognized rules of technical safety. In spite of this, its use poses inherent risks which could result in bodily harm or even death of the user or third persons, or damage to the grinding machine or other property.

The grinding machine may be used only:

- for its intended purpose, and
- in faultless condition with regard to safety-related aspects.

## 2. Safety

---

Malfunctions that may impair safety are to be eliminated immediately.

### 2.1.5 Malfunctions

If safety-relevant malfunctions occur with the grinding machine, or if the processing behavior indicates that such malfunctions may have occurred, the grinding machine must be stopped immediately and until such time as the malfunction has been found and eliminated.

Allow only authorized trained personnel to eliminate the malfunctions.

## 2.2 Intended use

The grinding machine is only suitable for grinding and polishing hand knives of 50–550 mm in length.

Any other use is considered to be improper. KNECHT Maschinenbau GmbH is not liable for any damage arising from this. The user alone bears this risk.

Use as intended includes the observance of all the notes in the operating instructions.

The grinding machine is being used improperly if, for example:

- fixtures are not properly attached.
- knives are grounded/polished in the opposite direction of the cutting edge on the grinding or polishing disk.
- work pieces other than hand knives are ground.

## 2.3 Warranty and liability

Warranty and liability claims in case of personal injuries or property damage are excluded if such injury/damage is attributable to one or more of the following causes:

- improper use of the grinding machine,
- improper transport, commissioning, operation, and maintenance of the grinding machine,
- operating the grinding machine with defective safety devices, or using improperly attached or malfunctioning safety and protective equipment,
- failure to observe the instructions with regard to transportation, commissioning, operation, maintenance and repair of the grinding machine,
- unauthorized structural alterations to the grinding machine,
- unauthorized modification, e.g. of the drive conditions (output and speed),

## 2. Safety

---

- failure to monitor machine parts that are subject to wear, and
- use of unapproved replacement and wear parts.

Use only original replacement and wear parts. When using external parts, it cannot be guaranteed that they are constructed and manufactured to be suitable and safe.

### 2.4 Safety regulations

#### 2.4.1 Organizational measures

Inspect all available safety devices regularly.

Observe prescribed intervals for recurring maintenance work or as specified in the operating instructions!

#### 2.4.2 Protective equipment

Before every commissioning of the grinding machine, ensure that all protective equipment is properly mounted and in functional condition.

Protective equipment may be removed only after the grinding machine has stopped and has been secured against accidental restart.

When delivering spare parts, the protective equipment must be attached by the operator as stipulated.

#### 2.4.3 Informal safety measures

The operating instructions must be permanently available at the place of use of the grinding machine. In addition to the operating instructions, the generally applicable as well as the locally relevant accident prevention regulations must also be made available and observed.

All safety alert symbols and hazard warnings on the grinding machine must be complete and clearly legible.

#### 2.4.4 Selection and qualification of personnel

Only trained and instructed personnel may work on the grinding machine. Observe the legally permitted minimum age!

The responsibilities of personnel with respect to commissioning, operation, maintenance, and repair must be clearly specified.

Personnel still undergoing training or instruction may only work on the grinding machine under the permanent supervision of an experienced person!

## 2. Safety

---

### 2.4.5 Machine control system

Only trained and instructed personnel are permitted to switch on the machine.

### 2.4.6 Safety measures in normal operation

Do not operate the machine in any unsafe manner. Only operate the grinding machine if all the safety devices are installed and fully functional.

Check the grinding machine for external signs of damage and correct operation of the safety devices at least once a day or once every 8 hour shift.

Immediately report any changes present (including those of the operating behavior) to the responsible office or person. If necessary, immediately shut down the grinding machine and secure it against restart.

Before you switch on the grinding machine, ensure that no one can be injured by the start-up of the machine.

In the event of a malfunction, immediately stop the grinding machine and secure it against restart. Rectify malfunctions immediately.

### 2.4.7 Hazards due to electrical power sources

Work on electrical systems or operating materials may only be performed by a qualified electrician in accordance with electrical regulations.

Defects, such as damaged cables, cable connections, etc. must be immediately rectified by an authorized specialist.

### 2.4.8 Particular hazard zones

In the area around the grinding and polishing disk, there is a risk that clothing, fingers and hair may be pinched and drawn in. Wear suitable personal protective equipment.

### 2.4.9 Servicing (maintenance, repair) and fault rectification

Maintenance work is to be carried out on schedule by trained personnel. Inform operating personnel before beginning repair work. Designate a supervisor responsible for this.

For all service work, the grinding machine is to be disconnected from the current supply and secured against accidental restart. Remove power plug. Cordon off the repair area as far as it is required.

After completing maintenance work and fault rectification, install all safety devices and verify that they are fully functional.

## 2. Safety

---

### 2.4.10 Structural alterations to the grinding machine

Alterations to or retrofits or rebuilds of the grinding machine are not allowed without the permission of the manufacturer. This also applies for installation and configuration of the safety devices.

Any conversion work requires the written permission from KNECHT Maschinenbau GmbH.

Immediately replace any machine parts that are not in a serviceable state.

Use only original replacement and wear parts. When using external parts, it cannot be guaranteed that they are constructed and manufactured, so as to be suitable and safe.

### 2.4.11 Cleaning the machine

Properly handle any cleaning agents and materials used and dispose of them in an environmentally-friendly manner.

Dispose of the wear parts and replacement parts in a safe and environmentally-friendly manner.

### 2.4.12 Oils and greases

When using oils and greases, follow the safety regulations applicable to the product. Comply with the special regulations for the foodstuffs sector.

### 2.4.13 Relocation of the grinding machine

Disconnect the grinding machine from any external current supply, even if adjusting its position slightly. Before restarting the grinding machine, properly connect it to the current supply.

# 3. Description

---

## 3.1 Intended use

The EVO 5 hand knife sharpening machine can be used to sharpen and polish hand knives.

## 3.2 Technical specifications

### 3.2.1 General information

Height	420 mm
Width	350 mm
Depth	350 mm
Space requirements (DxW)	500x600 mm
Weight	approx. 20 kg
Electrical supply*	1x 230 V
Mains frequency*	50 Hz
Electrical output*	0.25 kW
Power consumption*	0.25 kW
Current consumption*	1.95 A
Back-up fuse	16 A
Idle noise level	approx. 71dB (A)
Wet-grinding wheel diameter	150 mm
Operating noise level of the wet-grinding wheel	approx. 73 dB (A)
Polishing disk diameter	210 mm
Operating noise level of the polishing disk	approx. 76 dB (A)
Speed	2800 1/min

\*) This information may change depending on the electrical current supply.

A "Giesser" hand knife was sharpened to determine these data.

## 3. Description

---

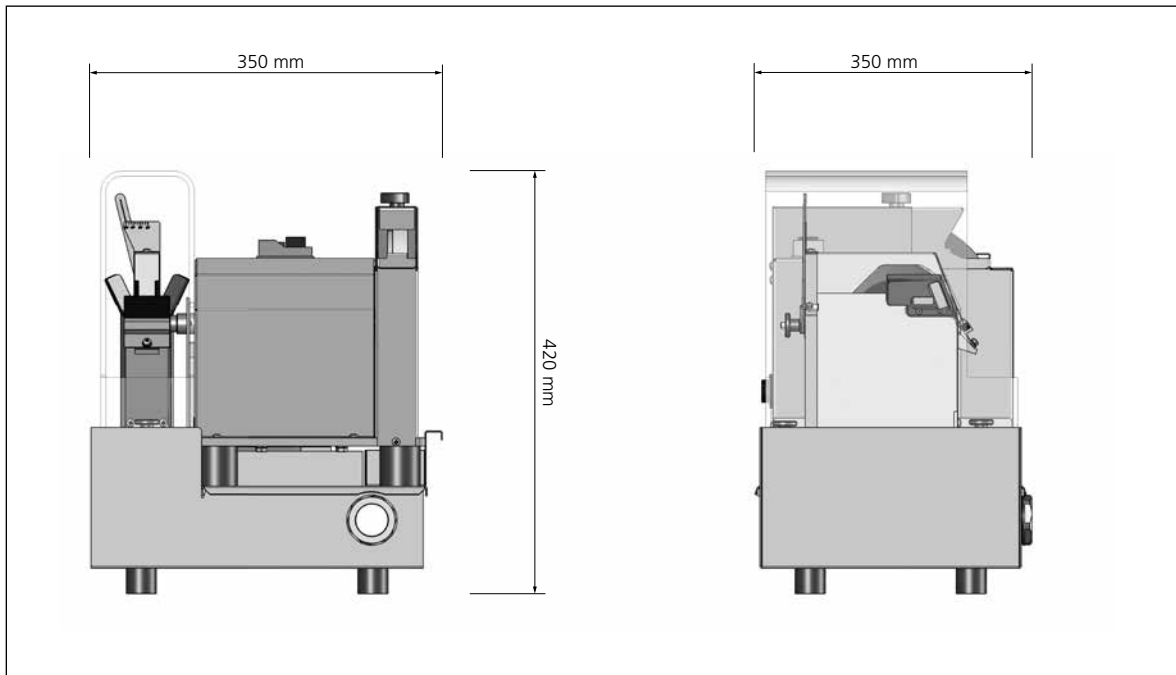

**Figure 3-1** Dimensions in mm

### 3.3 Functional description

The EVO 5 hand knife sharpening machine can be used to grind and polish hand knives of 50–550 mm length.

The machine is equipped with a double wet-grinding wheel set and a polishing disk.



# 3. Description

## 3.4 Description of components



**Figure 3-2** Overall view of sharpening machine

- 1 Splash guard
- 2 Angle adjustment
- 3 Wet-grinding wheels
- 4 Knife guides
- 5 Water tray
- 6 Polishing disk
- 7 Water level indicator

# 3. Description

---



- 1 Dirt tray
- 2 Suction socket

**Figure 3-3** Dirt tray with suction socket

## 3.4.1 Control panel



- 1 "ON/OFF" switch

**Figure 3-4** Control panel

## 4. Transport

---



**When transporting, observe the local applicable safety and accident prevention regulations.**

**Only transport the grinding machine with the machine feet facing downwards.**

### 4.1 Transport aids

For transporting and for setting up of the grinding machine, only use adequately dimensioned transport aids.

### 4.2 Transport damage

If damage is detected after unloading when accepting delivery, notify KNECHT Maschinenbau GmbH and the forwarding agent immediately. Promptly refer to an independent specialist as needed.

Remove the packaging and shipping straps. Remove the shipping straps on the grinding machine. Dispose of packaging in an environment-friendly manner.

### 4.3 Transport to another installation site

For transport to another installation site, ensure that the space requirements are fulfilled (see section 3.2).

A permissible electrical connection must be provided at the new installation site. The grinding machine must be firmly and securely fixed in place.



**Work on the electrical unit is only to be carried out by an authorized specialist. Observe the locally applicable safety and accident prevention regulations.**

# 5. Installation

---

## 5.1 Selection of qualified personnel



We recommend having installation work on the grinding machine carried out by the trained KNECHT personnel.

We are not liable for any damage resulting from improper installation.

## 5.2 Installation site

When determining the installation site, bear in mind the space required for installation as well as maintenance and repair work on the grinding machine (see section 3.2).

## 5.3 Supply connections

The grinding machine is provided ready to connect with the corresponding connection cable.



Ensure that the machine is correctly connected to the current supply.

## 5.4 Settings

KNECHT Maschinenbau GmbH will configure the various components as well as the electrical system before delivery.

**ATTENTION**

**Unauthorized alterations to the preset values are not permitted and can damage the grinding machine.**

# 5. Installation

---

## 5.5 Initial start-up of the grinding machine

Place the grinding machine on a flat table or base at the site it is to be installed.

Have an authorized electrician install the current supply on-site.

Completely install and inspect the protective equipment before commissioning.



CAUTION

**Have all protective equipment checked for proper functioning by authorized trained personnel before commissioning the machine.**

## 6. Commissioning



**CAUTION**

All work on the machine may only be performed by authorized trained personnel.

Observe the locally applicable safety and accident prevention regulations.

There is a risk that hands, hair, and clothing may be pulled in while the grinding machine is switched on.

Serious injury may result. Wear personal protective equipment.



Figure 6-1 Filling the water tray.

Fill water tray (6-1/1) with approx. 3.5 liters of water.

Connect the machine plug with the outlet (1x 230 V, 16 A) available on-site.

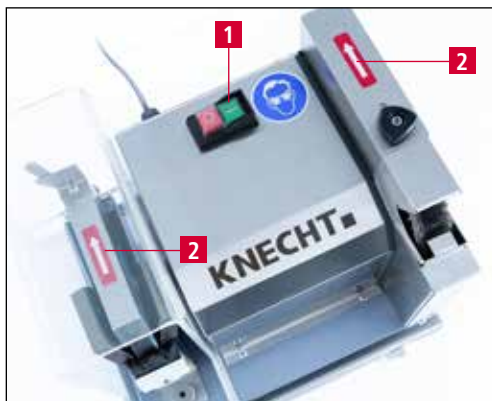

Figure 6-2 Checking the direction of rotation

Turn on the grinding machine by pressing the "ON/OFF" switch (6-2/1). Wet-grinding wheels and polishing disk are now turning.

Check the direction of rotation. The direction arrow (6-2/2) indicate the direction of rotation of the grinding wheels and polishing disk.

After ensuring that direction of rotation is as required, turn off the grinding machine.

**ATTENTION**

If the direction of rotation is not correct, immediately stop the machine, secure it and notify the KNECHT service.

# 7. Operation

---

## 7.1 General grinding fundamentals

To sharpen a blunt edge, metal must be removed from the knife by sharpening the hand knife to the cutting edge until a small burr is produced.

The burr is gently removed with the polishing disk under moderate pressure. The hand knife is led approx. 6 times alternately to the left and to the right over the polishing disk (left – right – left – right – left).

Since a cutting edge is defined not only by its sharpness but also by its service life, the cutting edge angle is another important performance indicator. The smaller the cutting edge angle, the longer the service life is theoretically. In practice, however, if the cutting edge angle is too small, the cutting edge breaks off and is therefore no longer sharp.

The cutting edge angles are therefore between 25° and 35°. At cutting angles below 15°, the cutting edge becomes so unstable that it bends at the slightest resistance. At a cutting edge angle of more than 40° the cutting edge is extremely stable but loses its sharpness very quickly.

Basically, the following applies: The cutting edge angles specified by the manufacturer must be observed.



**There is a risk that hands, hair, and clothing may be pulled in while the grinding machine is switched on.**

**Serious injury may result!**

## 7.2 Turning on the grinding machine

Turn on the grinding machine with "ON/OFF" switch (3-4/1).

Grinding wheels and polishing disk are now turning.

## 7.3 Adjusting the grinding angle



To adjust the grinding angle, loosen the knurled nut (7-1/1), set the desired grinding angle (7-1/2) and tighten the nut (7-1/1) again.

**Figure 7-1** Setting the grinding angle

# 7. Operation

---

## 7.4 Sharpening the hand knives on the wet-grinding wheel

### NOTE

**Knives must be cleaned before sharpening.**



**Figure 7-2** Sharpening hand knives

For sharpening, place the hand knife as close as possible to the handle in the knife guide (7-2/1). The knife guide is magnetic and supports the exact guidance.

Position the blade horizontally and pull it slowly towards the tip along the grinding wheel with even pressure.

In the area of the knife tip, move the handle upwards according to the shape of the knife.



**Figure 7-3** Sharpening hand knives

Repeat the process alternately on the right and left side until a fine burr is produced.

Then deburr and polish the hand knife on the polishing disk as described in chapter 7.5.

After completion of the sharpening process, turn the grinding machine off with the "ON/OFF" switch (3-4/1).

### NOTE

**Knives must be cleaned and disinfected after polishing.**



# 7. Operation

## 7.5 Polishing and deburring on the polishing disk



CAUTION

There is a risk that hands, hair, and clothing may be pulled in while the grinding machine is switched on.

Never hold the cutting edge against the rotation direction of the polishing disk. Serious injury may result!

Polishing gives rise to grinding particles that could enter the eyes. Wear safety glasses. Wear a face mask.



Figure 7-4 Applying the polishing paste

Turn on the grinding machine.

Hold the polishing paste (7-4/1), applying little pressure for a short time against the turning polishing disk (7-4/2).



Figure 7-5 Polishing hand knives

To polish/deburr, place the knife on the polishing disk (7-5/1).

The burr is gently removed with the polishing disk under moderate pressure. For this purpose, the hand knife is guided approx. 6 times alternately to the left and right over the polishing disk (left – right – left – right – left).

Turn the grinding machine off after completion of the polishing process.

### NOTE

Polish the blade only until the burr is removed.

Apply the polishing paste to the polishing disk after approx. 5–10 knives have been polished.

# 7. Operation

## 7.6 Replacing the wet-grinding wheel



For all work on the grinding machine, the locally applicable safety and accident prevention regulations as well as instructions in the “Safety” and “Important notes” section of the operating instructions must be observed.

**Pull out the mains plug before the grinding wheel replacement.**

**Never switch on the machine without the covers on. Risk of injury!**

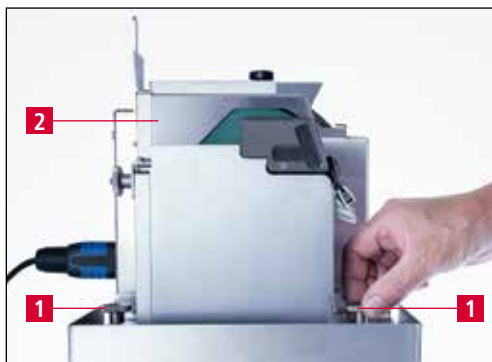

Figure 7-6 Removing knife guide unit

Loosen the knurled nut (7-6/1) counterclockwise and remove the complete knife guide unit (7-6/2) upwards.

### NOTE

**Replace the grinding wheels only in pairs!**

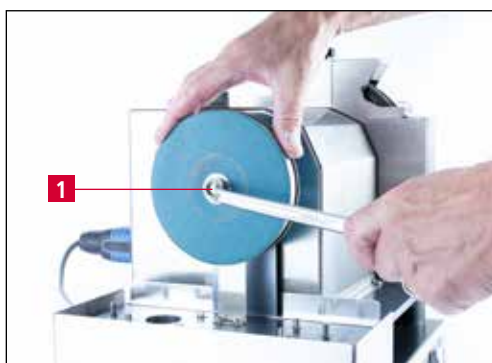
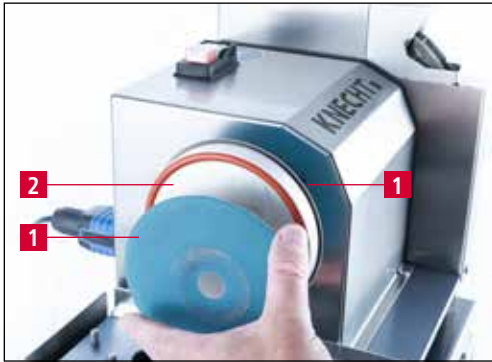

Figure 7-7 Loosening screws

Loosen and remove the screw (7-7/1) counterclockwise with SW 10 ring spanner.

# 7. Operation

---



**Figure 7-8** Removing used grinding wheels

Remove the used wet-grinding wheels (7-8/1), including the mounting (base body) (7-8/2).



**Figure 7-9** Installing a new pair of grinding wheels

Place a pair of new grinding wheels on the mounting (7-9/1) and put everything together in the shaft.

Tighten the screw (7-7/1) again.

Rinse the complete knife guide unit under running water.

Fit the knife guide unit again and fasten it with the knurled nut (7-6/1).

# 7. Operation

## 7.7 Replacing the polishing disk



For all work on the grinding machine, the locally applicable safety and accident prevention regulations as well as instructions in the “Safety” and “Important notes” section of the operating instructions must be observed.

Pull out the mains plug before the polishing disk replacement.

Never switch on the machine without the covers on. Risk of injury!



Figure 7-10 Loosening the polishing disk cover

Loosen the two screws (7-10/1) at the rear of the machine with a T 20 Torx screwdriver.



Figure 7-11 Loosening the polishing disk cover

Loosen the screw (7-11/1) in the front of the machine with a T 20 Torx screwdriver.

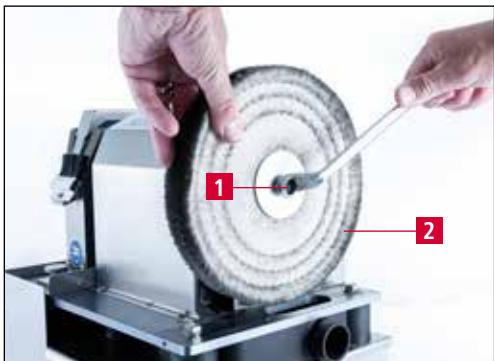

Figure 7-12 Removing the polishing disk cover

Remove the polishing disk cover (7-12/1) upwards.

## 7. Operation

---



**Figure 7-13** Loosening the polishing disk

Loosen the clamping screw of the polishing disk (7-13/1) clockwise (left-hand thread) with SW 13 ring spanner.

Remove the used polishing disk (7-13/2).

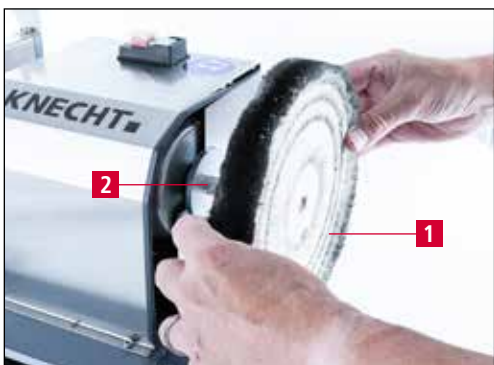

**Figure 7-14** Replacing the polishing disk

Insert and tighten a new polishing disk (7-14/1) in the shaft (7-14/2).

Rinse the polishing disk cover under running water.

Fit the cover again and fasten it with the three screws (7-10/1) and (7-11/1).

### NOTE

**The clamping screw (7-13/1) of the polishing disk has a left-hand thread.**

# 7. Operation

---

## 7.8 Suction unit (optional)



**Figure 7-15** Dirt tray with a suction socket

As a standard, the dirt tray (7-15/1) of EVO5 is furnished with a suction socket (7-15/2) for a commercial industrial vacuum cleaner.

### NOTE

**No industrial vacuum cleaner is included in the standard delivery.**

## 8. Care and maintenance

---



CAUTION

For all work on the grinding machine, the locally applicable safety and accident prevention regulations as well as instructions in the «Safety» and «Important notes» section of the operating instructions must be observed.

### 8.1 Cleaning

The machine must be cleaned daily, otherwise the grinding abrasion dries up and becomes very difficult to remove.

After rough cleaning, we recommend the products mentioned below to take care of the machine (see also the lubrication schedule, chapter 8.1.1). The coolant must be replaced daily.

**ATTENTION**

**The grinding machine must not be sprayed with water.**

#### 8.1.1 Lubrication schedule and lubricant table

Lubrication work	Cycle	INTERFLON	WÜRTH	SHELL	EXXON Mobil
Cleaning and care of machine parts	Daily	Dry clean stainless steel	Stainless steel care spray	Risella 917	Marcol 82

### 8.2 Maintenance plan (one-shift operation)

Cycle	Assembly	Maintenance task
Daily	Water tray	Replacing the coolant
	Magnetic bar	Remove and dispose of the grinding abrasion; clean the magnetic bar under running water
	Knife guide unit	Clean under running water, afterwards spray with care spray
	Entire grinding machine	Clean with a soft cloth and care spray
Weekly	Polishing disk cover	Dispose of the polishing abrasion and clean the polishing disk cover under running water, afterwards spray with care spray
Annually		Contact the service department of KNECHT Maschinenbau GmbH.

# 9. Disassembly and disposal

---

## 9.1 Disassembly

All operating materials must be disposed of properly.

Secure moving parts against slippage.

Disassembly must be conducted by a qualified specialist.

## 9.2 Disposal

After the machine has reached the end of its service life, it must be disposed of by a qualified specialist. In exceptional situations, and after consultation with KNECHT Maschinenbau GmbH, the machine may be returned.

Operating materials (e.g., wet-grinding wheels, polishing disks, etc.) must also be disposed of correctly.



# 10. Service, spare parts and accessories

---

## 10.1 Postal address

KNECHT Maschinenbau GmbH  
Witschwender Straße 26  
88368 Bergatreute  
Germany

Phone +49-7527-928-0  
Fax +49-7527-928-32

mail@knecht.eu  
www.knecht.eu

## 10.2 Service

### **Service line:**

For address, see postal address

service@knecht.eu

## 10.3 Wear and spare parts

If you need spare parts, please use the spare parts list provided with the machine. Please place your order using the format described below.

<b>When ordering, please always provide:</b>	<b>(Example)</b>
Machine type	(EVO 5)
Machine serial number	(050767EVO 5)
Drawing number	(EVO 5 spare part drawing page 3)
Item No.	(26)
Name of individual part	(Wet-grinding wheels set of 2 EVO 5)
Article number	(412B-00-0020)
Quantity	(1 pc.)

We are always happy to answer any questions.

# 10. Service, spare parts and accessories

---

## 10.4 Accessories

### 10.4.1 Abrasives used, etc.

Designation	Dimensions	Grain	Article number	Note
Wet-grinding wheel set of 2	d.150	150	412B-00-0020	Installed on delivery
Polishing disk	d.210		412Z-01-0010	Installed on delivery
Polishing paste	95x30 mm		412Z-02-0010	Included in delivery

### ATTENTION

Only original abrasives of KNECHT Maschinenbau GmbH can be used.

KNECHT Maschinenbau GmbH is not liable in the event that other abrasives are used.

If you require wet-grinding wheels, polishing disks or other accessories, please contact our sales staff, distributors, or KNECHT Maschinenbau GmbH directly.

Thank you for choosing KNECHT!

# 11. Annex

---

## 11.1 EU Declaration of conformity

in accordance with the EU Directive 2006/42/EU

- Machines 2006/42/EU
- Electromagnetic compatibility 2014/30/EU

We hereby declare that the machine designated as follows, due to its construction and design as well as the version we introduced on the market, complies with the relevant basic safety and health requirements of the applicable EU Directive.

If the machine is modified in a manner that we haven't approved, this declaration shall no longer be valid.

<b>Designation of the machine:</b>	Hand Knife Sharpening Machine
<b>Model designation:</b>	EVO 5
<b>Applicable conforming standards, especially:</b>	DIN EN 12100-1 DIN EN 12100-2 DIN EN 60204-1 ISO 13857 DIN EN 349
<b>Responsible for the documentation:</b>	Peter Heine (B. Eng. Mechanical Engineering, BA) Tel. +49-7527-928-15
<b>Manufacturer:</b>	KNECHT Maschinenbau GmbH Witschwender Straße 26 88368 Bergatreute Germany

Technical documentation is available and complete. The operating instructions document for the machine is available in its original version and in the native language of the user.

The validity of the declaration expires in the event of changes to legislation.

Bergatreute, August 12, 2020

KNECHT Maschinenbau GmbH



Manfred Knecht  
Managing Director



Markus Knecht  
Managing Director

**KNECHT Maschinenbau GmbH**

Witschwender Straße 26 · 88368 Bergatreute · Germany · T +49-7527-928-0 · F +49-7527-928-32  
mail@knecht.eu · www.knecht.eu